

Sedna

Anahtar - Priz serisi

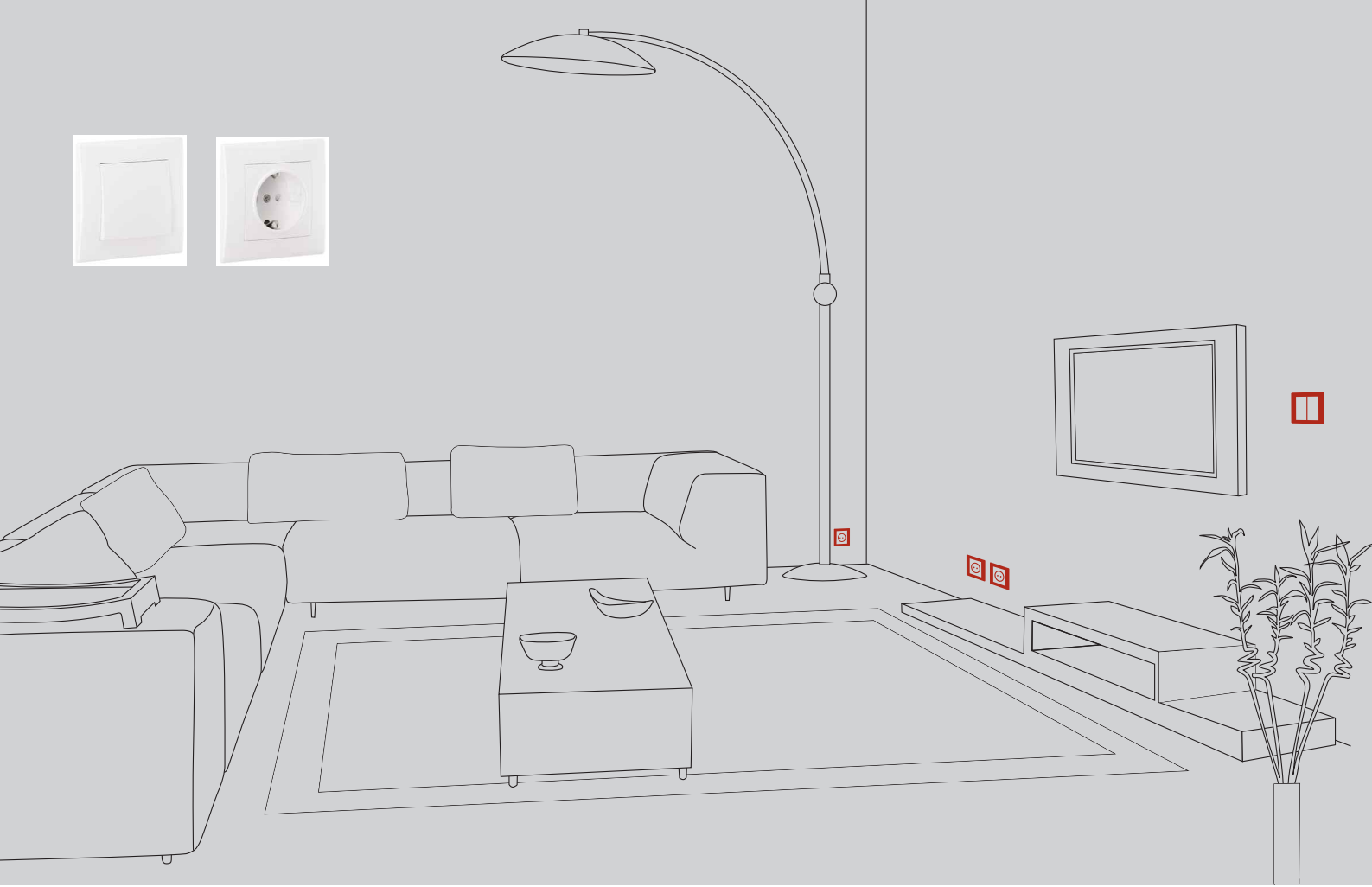

Müşteri Yardım Hattı

444 30 30

TR-Hotline@schneider-electric.com

www.schneider-electric.com.tr

Schneider
Electric

Yeni bir Elektrik Dünyasının inşası.



Sedna: 0.8 cm

Sedna'nın sivaüstü yüksekliği sadece 0.8 cm.

Kimine göre ince bir düşünce, kimine göre dahice!

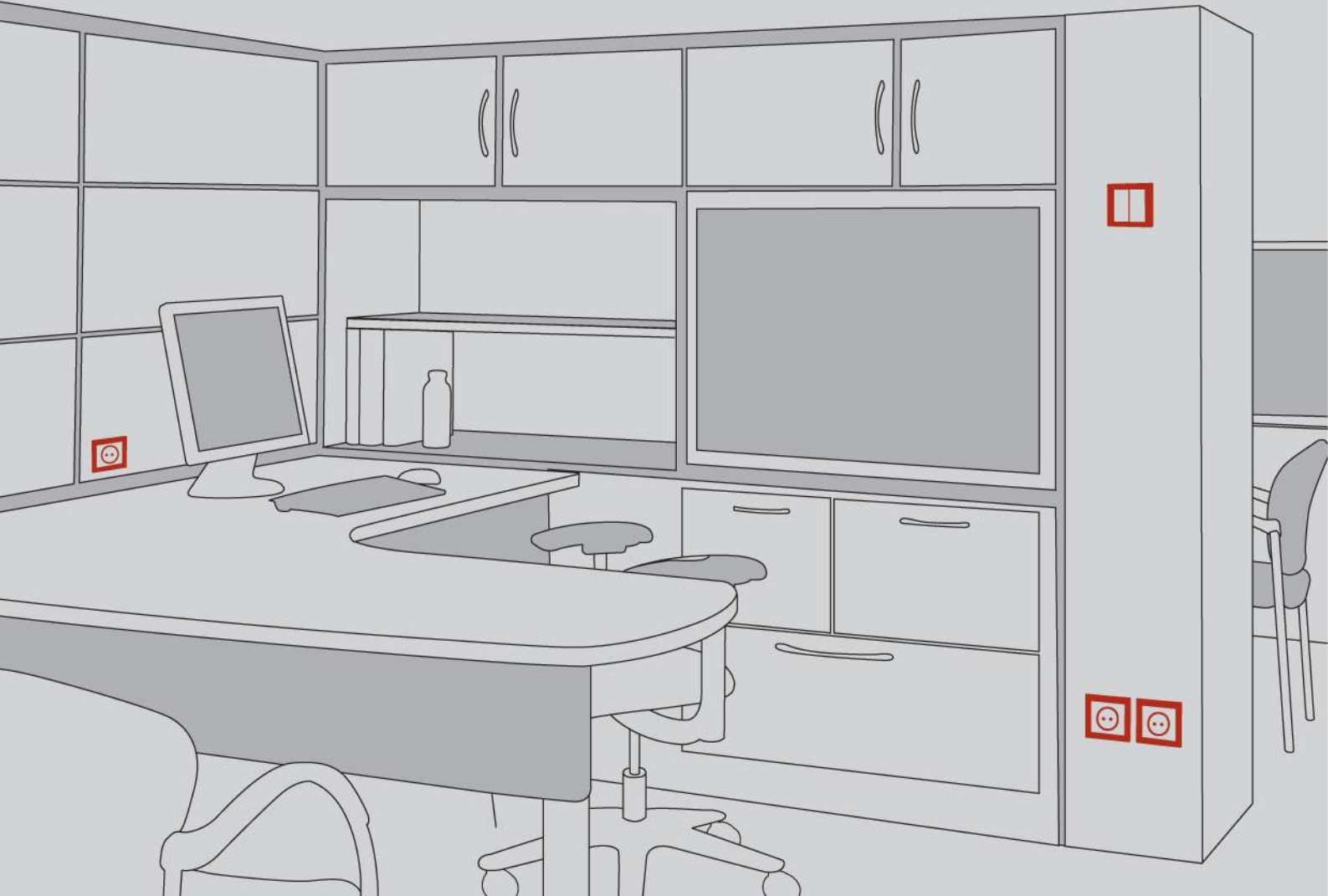

Sunum	2 - 7
Mekanizmalar	8 - 14
Çerçeveselr	15
Tasarım	16 - 17
Referans seçim tablosu.....	18 - 19

Sedna, beyaz & krem, renkli ve metalik serisi ile hayatınıza yeni renkler katıyor.



Sizlerin istekleri ve beğenileri gözönüne alınarak tasarlanan Sedna, zarif dizaynı ile sizlerle buluşuyor.



Sedna Beyaz & Krem



Değişik renkteki çerçeveleri ile kendi stilinizi oluşturabilirsiniz.

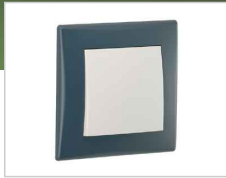

Sedna Renkli



Metalik Sedna'lar duvarlarınıza ışıltı veriyor.



Sedna Metalik



Artık telefon ile data prizini tek fonksiyonda kullanabileceksiniz. Lexcom markalı RJ45 data prizleri sayesinde hiçbir alete ihtiyaç duymadan kablolama yapabilirsiniz.

Eğimli girişi sayesinde kablo sıkışmalarına son.



Sedna konforunuz düşünülerek dizayn edildi. Uzaktan kumandalı dimmer sayesinde bulunduğunuz yerden, istediğiniz şiddette ışığı kontrol edebilirsiniz.



Siz yürüyün ışık hep önünüzde olacak. Gerekliği anda yolunuzu aydınlatmada, tasarruf sağlamada hareket dedektörü akıllıca bir seçim.





Duvarlarınızı 0.8 cm incelik ile süsleyin.

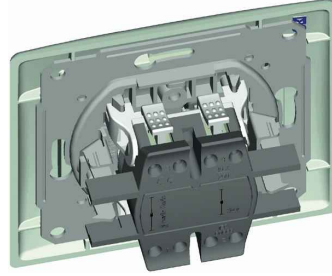

Paralel bağlantı uçları ve otomatik bağlantı özelliği sayesinde hızlı ve güvenli kablolama.



Çocukların güvenli bir yaşam sürebilmesi için tüm prizlerde standart olan çocuk koruma özelliği

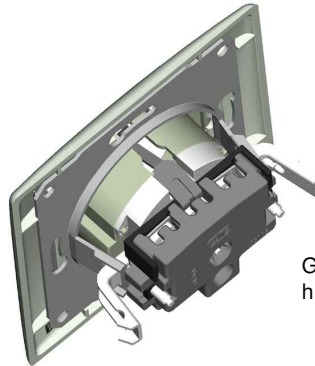

Geniş kablo girişleri sayesinde güvenli ve hızlı kablolama girişini sağlayan dizayn.

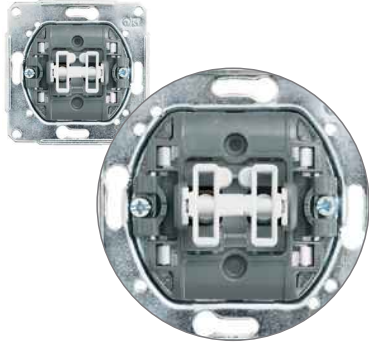

Sedna anahtar, tesisatçıların işini kolaylaştıracak şekilde dizayn edildi.

- elektrik şeması ile kusursuz kablolama
- sert tespitleme sacı
- otomatik bağlantı özelliği
- paralel bağlantı uçları
- yeterli kablolamaya izin veren sıvaaltı derinliği
- montaj ayakları ya da vida ile kolay montaj imkanı
- her tip CEE60 montaj kasasına uyumlu
- ara adaptörü çıkarmadan istediğiniz renkteki çerçeveyi kullanabilme

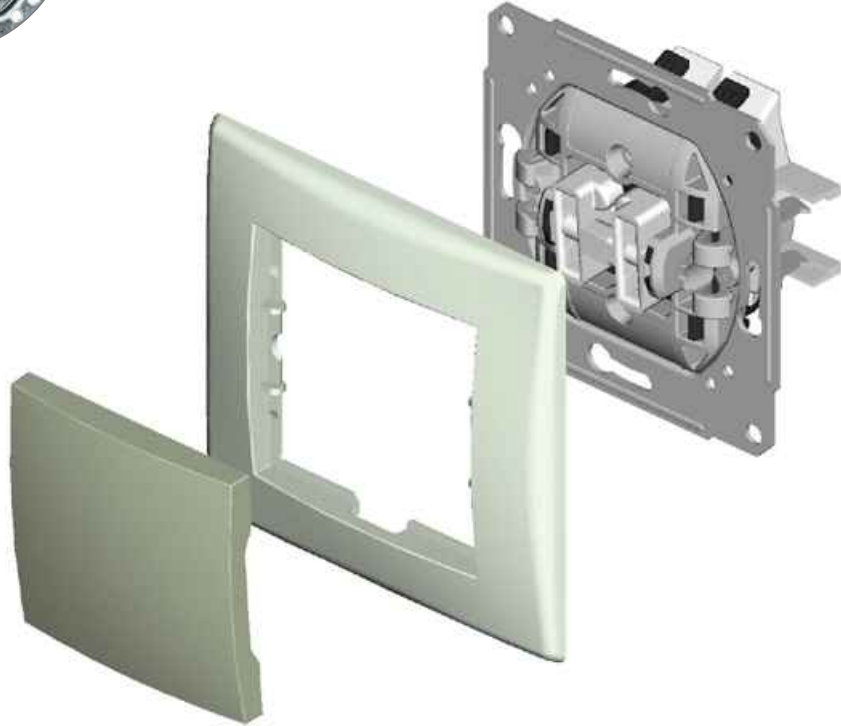

10'lu ve 20'li ambalaj

10'lu ve 20'li ambalajlar Sedna için özel olarak tasarlanmıştır.



OPP ambalaj

OPP ambalaj ile ürünlerin maksimum korunması sağlanmıştır.



Tüm ihtiya larınıızı karŐılayacak
fonksiyon ve renk  eŐitliliĐi...



Anahtar grubu



WDE SN4 0101 -- DFT



WDE SN4 0105 -- DFT

Anahtar 10 AX - 250V

	anahtar	komütatör
IP20		
	ref.	ref.
beyaz	WDE SN4 0101 21 DFT	WDE SN4 0105 21 DFT
krem	WDE SN4 0101 23 DFT	WDE SN4 0105 23 DFT
titanyum	WDE SN4 0101 68 DFT	WDE SN4 0105 68 DFT
alüminyum	WDE SN4 0101 60 DFT	WDE SN4 0105 60 DFT

Anahtar - iki kutuplu 10 AX - 250V

çift yönlü anahtar



WDE SN4 0102 -- DFT

IP20	
Screw	ref.
beyaz	WDE SN4 0102 21 DFT
krem	WDE SN4 0102 23 DFT
titanyum	WDE SN4 0102 68 DFT
alüminyum	WDE SN4 0102 60 DFT

Anahtar 10 AX - 250V

vavien

permütatör



WDE SN4 0106 -- DFT



WDE SN4 0107 -- DFT

	vavien	permütatör
IP20		
Screw	ref.	ref.
beyaz	WDE SN4 0106 21 DFT	WDE SN4 0107 21 DFT
krem	WDE SN4 0106 23 DFT	WDE SN4 0107 23 DFT
titanyum	WDE SN4 0106 68 DFT	WDE SN4 0107 68 DFT
alüminyum	WDE SN4 0106 60 DFT	WDE SN4 0107 60 DFT

Liht 10 AX - 250V

liht butonu

liht butonu (zil işaretli)

liht butonu (lamba işaretli)



WDE SN4 0161 -- DFT



WDE SN4 0161 -- JFT



WDE SN4 0161 -- IFT

	liht butonu	liht butonu (zil işaretli)	liht butonu (lamba işaretli)
IP20			
Screw	ref.	ref.	ref.
beyaz	WDE SN4 0161 21 DFT	WDE SN4 0161 21 JFT	WDE SN4 0161 21 IFT
krem	WDE SN4 0161 23 DFT	WDE SN4 0161 23 JFT	WDE SN4 0161 23 IFT
titanyum	WDE SN4 0161 68 DFT	WDE SN4 0161 68 JFT	WDE SN4 0161 68 IFT
alüminyum	WDE SN4 0161 60 DFT	WDE SN4 0161 60 JFT	WDE SN4 0161 60 IFT

Anahtar grubu

Anahtar 10 AX - 250V



WDE SN4 0417 ** DFT



WDE SN4 0601 ** DFT

	kordonlu liht butonu	jaluzi kumanda liht
IP20		
	ref.	ref.
beyaz	WDE SN4 0417 21 DFT	WDE SN4 0601 21 DFT
krem	WDE SN4 0417 23 DFT	WDE SN4 0601 23 DFT
titanyum	WDE SN4 0417 68 DFT	WDE SN4 0601 68 DFT
alüminyum	WDE SN4 0417 60 DFT	WDE SN4 0601 60 DFT

Işıklı anahtar grubu

Işıklı anahtar 10 A - 250V



WDE SN4 0121 ** DFT

	ışıklı anahtar
IP20	
	ref.
beyaz	WDE SN4 0121 21 DFT
krem	WDE SN4 0121 23 DFT
titanyum	WDE SN4 0121 68 DFT
alüminyum	WDE SN4 0121 60 DFT

Işıklı anahtar 10 A - 250V

ışıklı vavien



WDE SN4 0126 ** DFT

	ışıklı vavien
IP20	
	ref.
beyaz	WDE SN4 0126 21 DFT
krem	WDE SN4 0126 23 DFT
titanyum	WDE SN4 0126 68 DFT
alüminyum	WDE SN4 0126 60 DFT

Işıklı anahtar 10 A - 250V

ışıklı liht

ışıklı liht (zil işaretli)

ışıklı liht (lamba işaretli)



WDE SN4 0171 ** DFT



WDE SN4 0171 ** JFT



WDE SN4 0171 ** IFT

	ışıklı liht	ışıklı liht (zil işaretli)	ışıklı liht (lamba işaretli)
IP20			
	ref.	ref.	ref.
beyaz	WDE SN4 0171 21 DFT	WDE SN4 0171 21 JFT	WDE SN4 0171 21 IFT
krem	WDE SN4 0171 23 DFT	WDE SN4 0171 23 JFT	WDE SN4 0171 23 IFT
titanyum	WDE SN4 0171 68 DFT	WDE SN4 0171 68 JFT	WDE SN4 0171 68 IFT
alüminyum	WDE SN4 0171 60 DFT	WDE SN4 0171 60 JFT	WDE SN4 0171 60 IFT

Işıklı anahtar grubu

Energy saver 10 AX - 250V



WDE SN4 0401 ** DFT

IP20

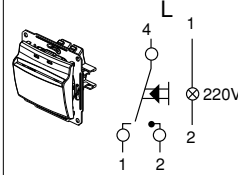

	ref.
□ beyaz	WDE SN4 0401 21 DFT
□ krem	WDE SN4 0401 23 DFT
□ titanyum	WDE SN4 0401 68 DFT
□ alüminyum	WDE SN4 0401 60 DFT

Elektronik ürünler



WDE SN4 4301 ** AFT



WDE SN4 4220 ** AFT

	hareket dedektörü	dimmer (600 W)
IP20		
	ref.	ref.
□ beyaz	WDE SN4 4301 21 AFT	WDE SN4 4220 21 AFT
□ krem	WDE SN4 4301 23 AFT	WDE SN4 4220 23 AFT
□ titanyum	WDE SN4 4301 68 AFT	WDE SN4 4220 68 AFT
□ alüminyum	WDE SN4 4301 60 AFT	WDE SN4 4220 60 AFT

- akkor ve halojen lambalar için
 - çalışma gerilimi : 230V, 40-320 w
 - 2 kablo girişi, algılama sahası: 5 m
 - algılama alanı: 110°
 - ışık şiddeti: 10 lux
 - gecikme zamanı: 180sn + 40, 90 sn + -20

- akkor ve halojen lambalar için
 - çalışma gerilimi : 230V, 60-600 w



WDE SN4 4221 ** AFT

	uzaktan kumandalı dimmer
IP20	
	ref.
□ beyaz	WDE SN4 4221 21 AFT
□ krem	WDE SN4 4221 23 AFT
□ titanyum	WDE SN4 4221 68 AFT
□ alüminyum	WDE SN4 4221 60 AFT

- akkor ve halojen lambalar için
 - çalışma gerilimi : 240V, 60-600 w
 - uzaktan kumanda çalışma frekansı: 433,92 Mhz



WDE SN4 3950 •• AFT

Elektronik ürünler

gecikmeli anahtar

IP20

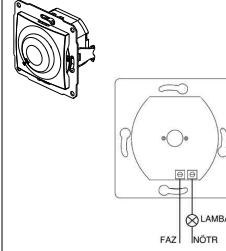

	ref.
□ beyaz	WDE SN4 3950 21 AFT
□ krem	WDE SN4 3950 23 AFT
□ titanyum	WDE SN4 3950 68 AFT
□ alüminyum	WDE SN4 3950 60 AFT

- akkor ve halojen lambalar için
- çalışma gerilimi : 230V, 700 w
- gecikme zamanı: 60 sn

Topraklı priz grubu (çocuk korumalı)

Priz 16 A - 250V a - 4000 W maks. (çocuk korumalı)



WDE SN4 3110 •• CFT



WDE SN4 3107 •• CFT



WDE SN4 3111 •• CFT

IP20

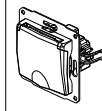
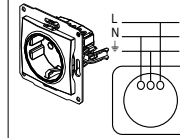
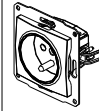

	UPS priz	topraklı priz	kapaklı topraklı priz
	ref.	ref.	ref.
□ beyaz	WDE SN4 3110 21 CFT	WDE SN4 3107 21 CFT	WDE SN4 3111 21 CFT
□ krem	WDE SN4 3110 23 CFT	WDE SN4 3107 23 CFT	WDE SN4 3111 23 CFT
□ titanyum	WDE SN4 3110 68 CFT	WDE SN4 3107 68 CFT	WDE SN4 3111 68 CFT
□ alüminyum	WDE SN4 3110 60 CFT	WDE SN4 3107 60 CFT	WDE SN4 3111 60 CFT

TV / FM - SAT, telefon, data prizleri

TV prizleri

sonlu, 0,2 dB,
5-862 Mhz

IP20

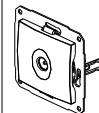

WDE SN4 5322 •• CFT

	ref.
□ beyaz	WDE SN4 5322 21 AFT
□ krem	WDE SN4 5322 23 AFT
□ titanyum	WDE SN4 5322 68 AFT
□ alüminyum	WDE SN4 5322 60 AFT

TV / FM - SAT, telefon, data prizleri



WDE SN4 5313 ** AFT WDE SN4 5314 ** AFT WDE SN4 5315 ** AFT

TV prizleri	geçişli, 5-862 Mhz 11 dB	geçişli, 5-862 Mhz 14 dB	geçişli, 5-862 Mhz 18 dB
IP20			
	ref.	ref.	ref.
beyaz	WDE SN4 5313 21 AFT	WDE SN4 5314 21 AFT	WDE SN4 5315 21 AFT
krem	WDE SN4 5313 23 AFT	WDE SN4 5314 23 AFT	WDE SN4 5315 23 AFT
titanyum	WDE SN4 5313 68 AFT	WDE SN4 5314 68 AFT	WDE SN4 5315 68 AFT
alüminyum	WDE SN4 5313 60 AFT	WDE SN4 5314 60 AFT	WDE SN4 5315 60 AFT



WDE SN4 5316 ** AFT WDE SN4 5335 ** AFT

TV / FM - SAT prizleri	sonlu, 1 dB 950-2400 Mhz	geçişli, 5 dB 5-862 Mhz
IP20		
	ref.	ref.
beyaz	WDE SN4 5316 21 AFT	WDE SN4 5335 21 AFT
krem	WDE SN4 5316 23 AFT	WDE SN4 5335 23 AFT
titanyum	WDE SN4 5316 68 AFT	WDE SN4 5335 68 AFT
alüminyum	WDE SN4 5316 60 AFT	WDE SN4 5335 60 AFT



WDE SN4 5202 ** AFT WDE SN4 5401 ** AFT WDE SN4 5402 ** AFT

Telefon prizleri	telefon prizi	1*RJ11	2*RJ11
IP20			
	ref.	ref.	ref.
beyaz	WDE SN4 5202 21 AFT	WDE SN4 5401 21 AFT	WDE SN4 5402 21 AFT
krem	WDE SN4 5202 23 AFT	WDE SN4 5401 23 AFT	WDE SN4 5402 23 AFT
titanyum	WDE SN4 5202 68 AFT	WDE SN4 5401 68 AFT	WDE SN4 5402 68 AFT
alüminyum	WDE SN4 5202 60 AFT	WDE SN4 5401 60 AFT	WDE SN4 5402 60 AFT

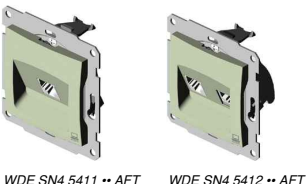

WDE SN4 5411 ** AFT WDE SN4 5412 ** AFT

Data prizleri	1*RJ45 Cat.5e-STP	2*RJ45 Cat.5e-STP
IP20		
	ref.	ref.
beyaz	WDE SN4 5411 21 AFT	WDE SN4 5412 21 AFT
krem	WDE SN4 5411 23 AFT	WDE SN4 5412 23 AFT
titanyum	WDE SN4 5411 68 AFT	WDE SN4 5412 68 AFT
alüminyum	WDE SN4 5411 60 AFT	WDE SN4 5412 60 AFT

- 25° eğimli çıkış
- kablo ucunu soymadan
bağlantı

- 25° eğimli çıkış
- kablo ucunu soymadan
bağlantı

TV / FM - SAT, telefon, data prizleri



WDE SN4 5413 ** AFT



WDE SN4 5414 ** AFT

Data prizleri

	1*RJ45 Cat.6-UTP	2*RJ45 Cat.6-UTP
IP20		
	ref.	ref.
beyaz	WDE SN4 5413 21 AFT	WDE SN4 5414 21 AFT
krem	WDE SN4 5413 23 AFT	WDE SN4 5414 23 AFT
titanyum	WDE SN4 5413 68 AFT	WDE SN4 5414 68 AFT
alüminyum	WDE SN4 5413 60 AFT	WDE SN4 5414 60 AFT
	- 25° eğimli çıkış - kablo ucunu soymadan bağlantı	- 25° eğimli çıkış - kablo ucunu soymadan bağlantı



WDE SN4 5415 ** AFT



WDE SN4 5416 ** AFT

Data prizleri

	1*RJ45 Cat.5e-STP	2*RJ45 Cat.5e-STP
IP20		
	ref.	ref.
beyaz	WDE SN4 5415 21 AFT	WDE SN4 5416 21 AFT
krem	WDE SN4 5415 23 AFT	WDE SN4 5416 23 AFT
titanyum	WDE SN4 5415 68 AFT	WDE SN4 5416 68 AFT
alüminyum	WDE SN4 5415 60 AFT	WDE SN4 5416 60 AFT
	- 25° eğimli çıkış - kablo ucunu soymadan bağlantı	- 25° eğimli çıkış - kablo ucunu soymadan bağlantı



WDE SN4 5417 ** AFT



WDE SN4 5418 ** AFT

Data prizleri

	1*RJ45 Cat.6-STP	2*RJ45 Cat.6-STP	RJ45 Cat.5e + RJ11
IP20			
	ref.	ref.	ref.
beyaz	WDE SN4 5417 21 AFT	WDE SN4 5418 21 AFT	WDE SN4 5419 21 AFT
krem	WDE SN4 5417 23 AFT	WDE SN4 5418 23 AFT	WDE SN4 5419 23 AFT
titanyum	WDE SN4 5417 68 AFT	WDE SN4 5418 68 AFT	WDE SN4 5419 68 AFT
alüminyum	WDE SN4 5417 60 AFT	WDE SN4 5418 60 AFT	WDE SN4 5419 60 AFT
	- 25° eğimli çıkış - kablo ucunu soymadan bağlantı	- 25° eğimli çıkış - kablo ucunu soymadan bağlantı	- 25° eğimli çıkış - kablo ucunu soymadan bağlantı

Tamamlayıcı fonksiyonlar



WDE SN4 4503 ** AFT WDE SN4 2601 ** AFT

	2'li hoparlör prizi	kablo çıkışlı 25 A
IP20		
beyaz	WDE SN4 4503 21 AFT	WDE SN4 2601 21 AFT
krem	WDE SN4 4503 23 AFT	WDE SN4 2601 23 AFT
titanyum	WDE SN4 4503 68 AFT	WDE SN4 2601 68 AFT
alüminyum	WDE SN4 4503 60 AFT	WDE SN4 2601 60 AFT
	- otomatik bağlantı	- 4*2, 5mm ² bağlantı girişi

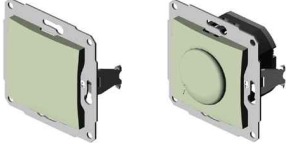

WDE SN4 2501 ** AFT WDE SN4 4501 ** AFT

	kör kapak	ses potansiyometresi (boş panel)
IP20		
beyaz	WDE SN4 2501 21 AFT	WDE SN4 4501 21 AFT
krem	WDE SN4 2501 23 AFT	WDE SN4 4501 23 AFT
titanyum	WDE SN4 2501 68 AFT	WDE SN4 4501 68 AFT
alüminyum	WDE SN4 2501 60 AFT	WDE SN4 4501 60 AFT
		- mekanizması ayrıca talep edilmelidir

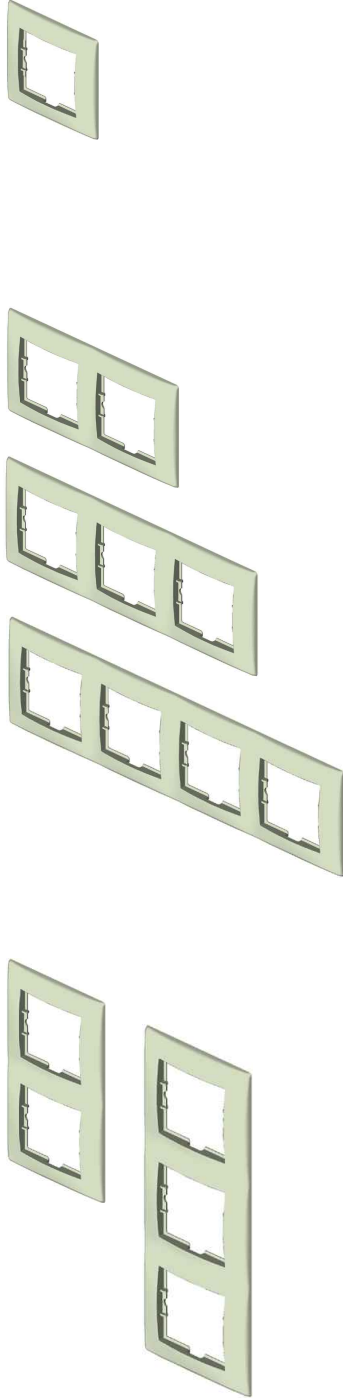

Çerçeveler

tekli çerçeve	
IP20	ref.
□ beyaz	WDE SN6 1401 21 AFT
□ krem	WDE SN6 1401 23 AFT
□ titanyum	WDE SN6 1401 68 AFT
□ alüminyum	WDE SN6 1401 60 AFT
■ füme	WDE SN6 1401 31 AFT
■ gri	WDE SN6 1401 33 AFT
■ bej	WDE SN6 1401 37 AFT
■ kırmızı	WDE SN6 1401 41 AFT
■ açık yeşil	WDE SN6 1401 51 AFT

	ikili çerçeve yatay	üçlü çerçeve yatay	dörtlü çerçeve yatay
IP20	ref.	ref.	ref.
□ beyaz	WDE SN6 1437 21 AFT	WDE SN6 1438 21 AFT	WDE SN6 1439 21 AFT
□ krem	WDE SN6 1437 23 AFT	WDE SN6 1438 23 AFT	WDE SN6 1439 23 AFT
□ titanyum	WDE SN6 1437 68 AFT	WDE SN6 1438 68 AFT	WDE SN6 1439 68 AFT
□ alüminyum	WDE SN6 1437 60 AFT	WDE SN6 1438 60 AFT	WDE SN6 1439 60 AFT
■ füme	WDE SN6 1437 31 AFT	WDE SN6 1438 31 AFT	WDE SN6 1439 31 AFT
■ gri	WDE SN6 1437 33 AFT	WDE SN6 1438 33 AFT	WDE SN6 1439 33 AFT
■ bej	WDE SN6 1437 37 AFT	WDE SN6 1438 37 AFT	WDE SN6 1439 37 AFT
■ kırmızı	WDE SN6 1437 41 AFT	WDE SN6 1438 41 AFT	WDE SN6 1439 41 AFT
■ açık yeşil	WDE SN6 1437 51 AFT	WDE SN6 1438 51 AFT	WDE SN6 1439 51 AFT

	ikili çerçeve dikey	üçlü çerçeve dikey
IP20	ref.	ref.
□ beyaz	WDE SN6 1445 21 AFT	WDE SN6 1446 21 AFT
□ krem	WDE SN6 1445 23 AFT	WDE SN6 1446 23 AFT
□ titanyum	WDE SN6 1445 68 AFT	WDE SN6 1446 68 AFT
□ alüminyum	WDE SN6 1445 60 AFT	WDE SN6 1446 60 AFT
■ füme	WDE SN6 1445 31 AFT	WDE SN6 1446 31 AFT
■ gri	WDE SN6 1445 33 AFT	WDE SN6 1446 33 AFT
■ bej	WDE SN6 1445 37 AFT	WDE SN6 1446 37 AFT
■ kırmızı	WDE SN6 1445 41 AFT	WDE SN6 1446 41 AFT
■ açık yeşil	WDE SN6 1445 51 AFT	WDE SN6 1446 51 AFT

Modern ve
zarif dizaynı
ile
duvarları
süsleyen bir
aksesuar...



Sedna
Beyaz & Krem

21 Beyaz



23 Krem

Sedna Renkli



37 Bej



51 Açık yeşil



33 Gri



31 Füme



41 Kırmızı

Sedna Metalik



60 Alüminyum



68 Titanyum

Bütün renkleri ister beyaz tuş kapaklı
ister krem tuş kapaklı mekanizma ile
kullanabilirsiniz.

Tanım	Referans	Minimum sip. adedi	Grup
Anahtar Grubu			
Sedna Anahtar	WDE SN4 0101 ** DFT	10	B
Sedna Çift yönlü anahtar	WDE SN4 0102 ** DFT	10	B
Sedna Komütatör	WDE SN4 0105 ** DFT	10	B
Sedna Vavien	WDE SN4 0106 ** DFT	10	B
Sedna Permütatör	WDE SN4 0107 ** DFT	10	B
Sedna Liht butonu	WDE SN4 0161 ** DFT	10	B
Sedna Liht butonu (Zil işaretli)	WDE SN4 0161 ** JFT	10	B
Sedna Liht butonu (Lamba işaretli)	WDE SN4 0161 ** IFT	10	B
Sedna Kordonlu liht butonu	WDE SN4 0417 ** DFT	10	B
Sedna Jaluzi kumanda liht	WDE SN4 0601 ** DFT	10	B
Işıklı Anahtar Grubu			
Sedna Işıklı anahtar	WDE SN4 0121 ** DFT	10	B
Sedna Işıklı vavien	WDE SN4 0126 ** DFT	10	B
Sedna Işıklı liht	WDE SN4 0171 ** DFT	10	B
Sedna Işıklı liht (Zil işaretli)	WDE SN4 0171 ** JFT	10	B
Sedna Işıklı liht (Lamba işaretli)	WDE SN4 0171 ** IFT	10	B
Sedna Energy saver	WDE SN4 0401 ** DFT	10	B
Elektronik ürünler grubu			
Sedna Hareket dedektörü 300W	WDE SN4 4301 ** AFT	8	C
Sedna Dimmer 600W	WDE SN4 4220 ** AFT	8	B
Sedna Uzaktan kumandalı dimmer	WDE SN4 4221 ** AFT	-	C
Sedna Gecikmeli anahtar	WDE SN4 3950 ** AFT	8	C
Priz Grubu			
Sedna UPS priz (Çocuk korumalı)	WDE SN4 3110 ** CFT	10	B
Sedna Topraklı priz (Çocuk korumalı)	WDE SN4 3107 ** CFT	10	B
Sedna Kapaklı topraklı priz (Çocuk korumalı)	WDE SN4 3111 ** CFT	10	B
TV/FM - SAT, telefon, data prizleri			
Sedna TV priz sonlu 0,2 dB	WDE SN4 5322 ** AFT	10	B
Sedna TV priz geçişli 11 dB	WDE SN4 5313 ** AFT	10	B
Sedna TV priz geçişli 14 dB	WDE SN4 5314 ** AFT	10	B
Sedna TV priz geçişli 18 dB	WDE SN4 5315 ** AFT	10	B
Sedna TV / FM -SAT priz sonlu 1 dB	WDE SN4 5316 ** AFT	10	B
Sedna TV / FM - SAT priz geçişli 5 dB	WDE SN4 5335 ** AFT	10	B
Sedna Telefon priz	WDE SN4 5202 ** AFT	10	B
Sedna 1*RJ11 - 4 kontaklı	WDE SN4 5401 ** AFT	10	B
Sedna 2*RJ11 - 4 kontaklı	WDE SN4 5402 ** AFT	10	B
Sedna 1*RJ45CAT5e-UTP	WDE SN4 5411 ** AFT	10	B
Sedna 2*RJ45CAT5e-UTP	WDE SN4 5412 ** AFT	10	B
Sedna 1*RJ45CAT5e-STP	WDE SN4 5415 ** AFT	10	B
Sedna 2*RJ45CAT5e-STP	WDE SN4 5416 ** AFT	10	B
Sedna 1*RJ45CAT6-UTP	WDE SN4 5413 ** AFT	10	C
Sedna 2*RJ45CAT6-UTP	WDE SN4 5414 ** AFT	10	C
Sedna 1*RJ45CAT6-STP	WDE SN4 5417 ** AFT	10	C
Sedna 2*RJ45CAT6-STP	WDE SN4 5418 ** AFT	10	C
Sedna RJ45 Cat5e + RJ11	WDE SN4 5419 ** AFT	10	B
Tamamlayıcı fonksiyonlar			
Sedna 2'li Hoparlör priz	WDE SN4 4503 ** AFT	10	C
Sedna Kablo çıkışı	WDE SN4 2601 ** AFT	10	B
Sedna Kör kapak	WDE SN4 2501 ** AFT	10	B
Sedna Ses potansiyometresi (boş panel)	WDE SN4 4501 ** AFT	10	C

**	Renkler
21	Beyaz
23	Krem
68	Titanyum
60	Alüminyum

Tanım	Referans	Minimum sip. adedi	Grup
Çerçeveler			
Sedna tekli çerçeve	WDE SN6 1401 ** AFT	30	B
Sedna ikili çerçeve yatay	WDE SN6 1437 ** AFT	25	B
Sedna üçlü çerçeve yatay	WDE SN6 1438 ** AFT	20	B
Sedna dörtlü çerçeve yatay	WDE SN6 1439 ** AFT	20	B
Sedna ikili çerçeve dikey	WDE SN6 1445 ** AFT	25	B
Sedna üçlü çerçeve dikey	WDE SN6 1446 ** AFT	20	B

**	Renkler
21	Beyaz
23	Krem
68	Titanyum
60	Alüminyum
31	Füme
33	Gri
37	Bej
41	Kırmızı
51	Açık yeşil

Modern ve zarif dizaynı ile duvarları süsleyen bir aksesuar...



Schneider Elektrik Sanayi ve Ticaret A.Ş.

Schneider Electric Müşteri Yardım Hattı

Tel : 444 3030

Faks : 0 216 468 8829

e-posta: TR-Hotline@schneider-electric.com

Standartlar ve donanımlarda meydana gelen değişiklikler nedeniyle, bu belgede yer alan karakteristikler ve resimler, tarafımızca teyit edilmedikçe bağlayıcı değildir.