

Leona

Eskimeyen ve özel tasarım
2020 Katalođu

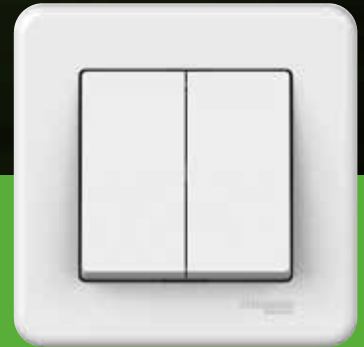

se.com/tr

Life Is On

Schneider
Electric

Life Is n

Schneider
 Electric

İçindekiler

- 4 Leona sunumu
- 6 Ürünler (çerçevesi)
- 11 Çerçeveler
- 12 Teknik bilgiler
- 15 Referanslar (sipariş kodları)

Leona - akıllı tasarım...

Yeni Leona anahtar serisi, pürüzsüz yuvarlak kenarlara sahiptir. Beyaz ve krem renklerdeki eskimeyen ve özel tasarım her eve yakışır.



Yenilikçi montaj sistemi

Leona çerçeveleri, tekliden dörtlüye kadar mevcuttur. Çerçeveler yatay ya da dikey olarak kurulabilir. Malzeme parlak olmasının yanı sıra son derece sağlamdır.

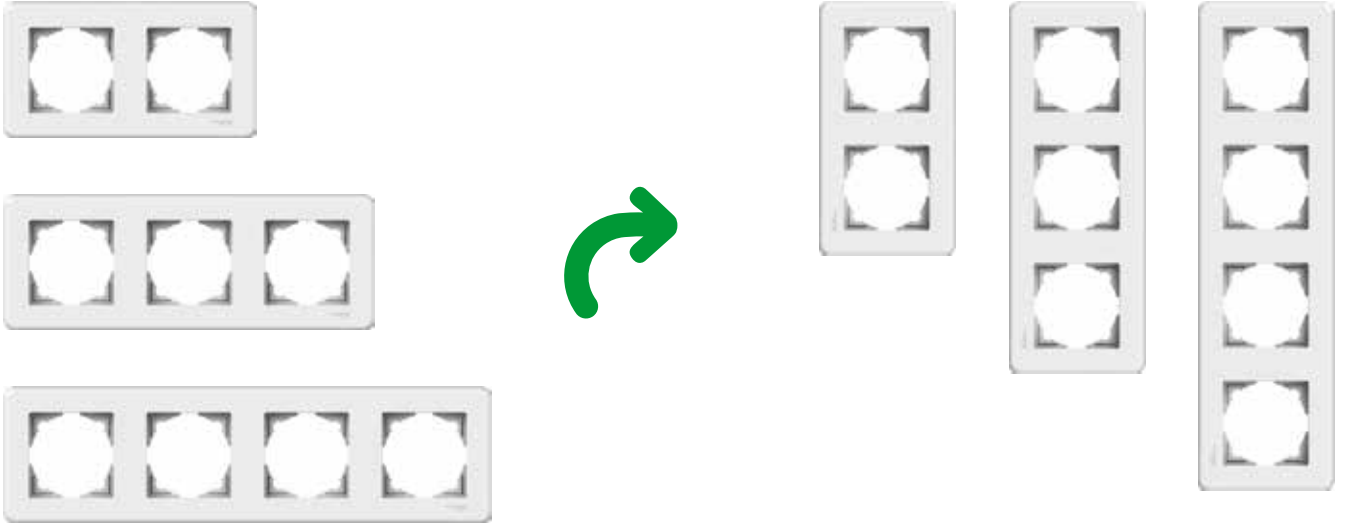

Leona; dimmerler, jaluzi kontrolü için liht butonlar, işaretli topraklı prizler ve iletişim grubu prizleri ile çok daha fazlasını içeren çok çeşitli fonksiyonlara sahiptir.



...basit kurulum

Çok çeşitli ürün özellikleri sayesinde, kurulum güvenli, hızlı ve kolaydır.

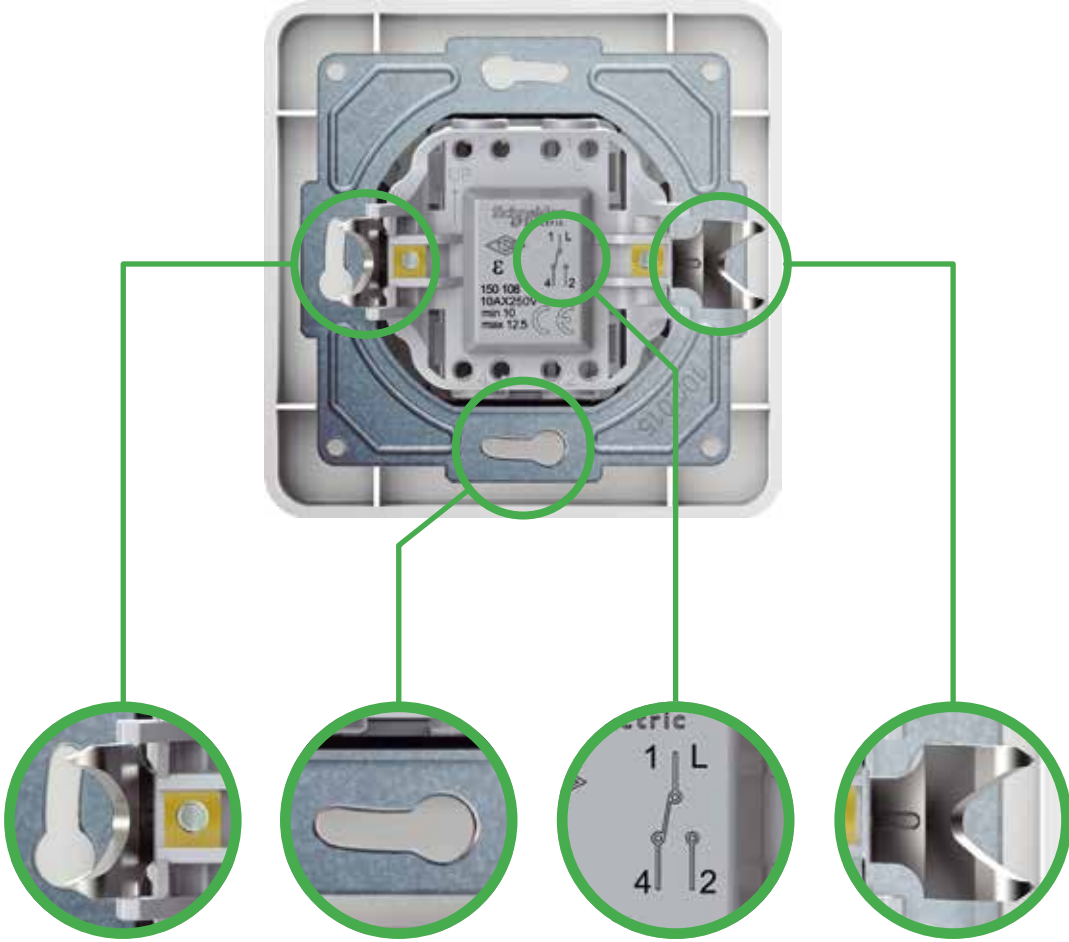

Vidalı ya da tırnaklı montaj

Kurulum sahasına veya davranışına göre, bütün Leona ek parçaları vidalarla ya da tırnaklarla monte edilebilir.

Güvenli kablo bağlantısı

Mekanizmanın üzerine basılmış olan kablo bağlantı şeması, fonksiyon bağlantısının nasıl yapılacağını gösterir.

Sağlam ve uzun ömürlü sabitleme











Tırnakların açısı, sağlam bir sabitleme sunmak için optimize edilmiştir.



Kontroller



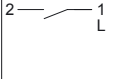
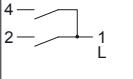
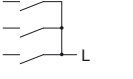
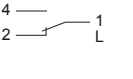
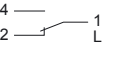
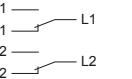
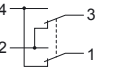

Anahtarlar ve liht butonlar

Ortak özellikler

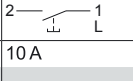
- Anma çalışma gerilimi: 250 V AC
- Bağlantı: vidalı terminaller
- Kelepçe bağlantı kapasitesi:
 - o anahtarlar: 2 x 2,5 mm² sert/esnek kablolar
 - o liht butonlar: 2 x 1,5 mm² sert/esnek kablolar
- Standart: IEC 60669-1
- Sertifikasyon: TSE
- Kalite etiketi: CE
- Koruma sınıfı: IP20, IP44 (LNA040042x)

Anahtarlar							
							
Anahtar	Komütatör	Üçlü anahtar	Vavien	Vavien - IP44	2'li vavien	Permütatör	
							
Anma akımı	10 AX						
Renk							
<input type="checkbox"/> beyaz	LNA0100321	LNA0300321	LNA2100321	LNA0400321	LNA0400421	LNA0600321	LNA0500321
<input type="checkbox"/> krem	LNA0100323	LNA0300323	LNA2100323	LNA0400323	LNA0400423	LNA0600323	LNA0500323

Liht butonlar		
		
Liht buton	Kapı otomatığı	Zil butonu
		
Anma akımı	10 A	
Renk		
<input type="checkbox"/> beyaz	LNA0700321	LNA0900321
<input type="checkbox"/> krem	LNA0700323	LNA0900323

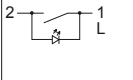
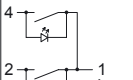
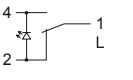
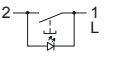
Işıklı anahtarlar			Işıklı liht butonlar
			
Işıklı anahtar	Işıklı komütatör	Işıklı vavien	Işıklı liht
			
Anma akımı	10 AX		10 A
Renk			
<input type="checkbox"/> beyaz	LNA1400321	LNA2000321	LNA1500321
<input type="checkbox"/> krem	LNA1400323	LNA2000323	LNA1500323

Ürünler (çerçevesiz)

Kontroller

Konfora yönelik kontroller

Jaluzi için mekanizmalar

Özellikler

- Anma çalışma gerilimi: 250 V AC
- Anma akımı: 10 A
- Bağlantı: vidalı terminaller
- Kelepçe bağlantı kapasitesi: 2 x 2,5 mm² sert/esnek kablolar
- Koruma sınıfı: IP 20
- Standart: IEC 60669-1
- Sertifikasyonlar: TSE
- Kalite etiketi: CE
- Koruma sınıfları: IP 20

Anahtar

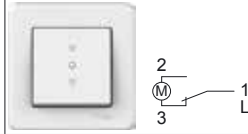



Renk	
<input type="checkbox"/> beyaz	LNA1300521
<input type="checkbox"/> krem	LNA1300523

Konfora yönelik kontroller

Dimmerler

Rezistif lambalar için dimmer









Renk	
<input type="checkbox"/> beyaz	LNA6400121
<input type="checkbox"/> krem	LNA6400123
Özellikler	
Dimmer kontrolü	Döner - AÇIK/KAPALI entegrasyonu
Nominal çalışma gerilimi	230 V AC, 50 Hz
Anma akımı	1,7 A
Minimum yük kesme kapasitesi	40 W
Kelepçe bağlantı kapasitesi	2 x 2,5 mm ² sert/esnek kablolar
Çalışma için ortam hava sıcaklığı	+5 ila +35 °C
Sertifikasyon	CE
Koruma sınıfı	IP20
Yükler	
Akkor lambalar	40 - 400 W
	
Halojen lambalar	40 - 400 W
	

Ürünler (çerçevesiz)

Şebeke prizleri

Özellikler

- Anma çalışma gerilimi: 250 V AC
- Anma akımı: 16 A
- Bağlantı: vidalı terminaller
- Kelepçe bağlantı kapasitesi:
 - 2P: 2 x 2,5 mm² sert/esnek kablolar
 - 2P+E: 3 x 2,5 mm² sert/esnek kablolar
- Standart: IEC 60884-1
- Sertifikasyon: TSE, BBJ
- Koruma sınıfı: IP20, IP44 (LNA280022x, LNA280052x)

	2P+E (topraklı)			2P+E (UPS priz)		
						
	Tek	Çocuk korumalı tek	Çocuk korumalı ve kapaklı tek	Tek	Çocuk korumalı ve IP44 kapaklı tek	İkili
Renk						
<input type="checkbox"/> beyaz	LNA2900121	LNA2900221	LNA3100221	LNA2800121	LNA2800521	LNA9800221
<input type="checkbox"/> krem	LNA2900123	LNA2900223	LNA3100223	LNA2800123	LNA2800523	LNA9800223

Ürünler (çerçevesiz)

İletişim grubu

Telefon prizleri

Özellikler

- Koruma sınıfı: IP20

Basit RJ11, 4 kontaklı



Çift RJ11, 4 kontaklı



Renk	Basit RJ11, 4 kontaklı	Çift RJ11, 4 kontaklı
<input type="checkbox"/> beyaz	LNA4100121	LNA4200121
<input type="checkbox"/> krem	LNA4100123	LNA4200123

TV-R-SAT prizleri

Ortak özellikler

- Koruma sınıfı: IP20

TV



TV-R



TV-SAT



TV-R-SAT



SAT



	TV	TV-R	TV-SAT	TV-R-SAT	SAT
Tür	Sonlu	Geçişli	Sonlu	Sonlu	Geçişli
Konnektörler	IEC dişi	IEC erkek + dişi	IEC erkek + F	IEC erkek + dişi + F	IEC erkek + dişi + F
Zayıflatma	4dB	7 dB	1 dB	1,5 dB	5 dB
Renk					
<input type="checkbox"/> beyaz	LNA3200121	LNA3300121	LNA3400121	LNA3500121	LNA3500221
<input type="checkbox"/> krem	LNA3200123	LNA3300123	LNA3400123	LNA3500123	LNA3500223

TV-R ve TV-SAT prizleri için kapak

Özellikler

- Koruma sınıfı: IP20



Renk	TV-R ve TV-SAT prizleri için kapak
<input type="checkbox"/> beyaz	LNA3400521
<input type="checkbox"/> krem	LNA3400523

RJ45 data prizleri

Özellikler

- Bağlantı: IDC terminalleri
- Koruma sınıfı: IP20

Cat. 5e UTP



Cat. 6 UTP



Renk	Cat. 5e UTP Tek	Cat. 5e UTP İkili	Cat. 6 UTP Tek	Cat. 6 UTP İkili
<input type="checkbox"/> beyaz	LNA4700121	LNA4400121	LNA4300121	LNA4800121
<input type="checkbox"/> krem	LNA4700123	LNA4400123	LNA4300121	LNA4800123

RJ45 + RJ11 data prizleri

Özellikler

- Koruma sınıfı: IP20

RJ45 cat.5e UTP + RJ11 4 kontakları

Renk	
<input type="checkbox"/> beyaz	LNA4900121
<input type="checkbox"/> krem	LNA4900123

Data prizleri için kapaklar

Özellikler

- Koruma sınıfı: IP20

Tek**İkili**

Renk		
<input type="checkbox"/> beyaz	LNA4301121	LNA4401121
<input type="checkbox"/> krem	LNA4301123	LNA4401123

Ses düzeyi kontrolü

Özellikler

- Anma çalışma gerilimi: 12 V DC
- Anma çalışma gücü: 5W
- Ortalama empedans: 4 Ω
- Kelepçe bağlantı kapasitesi: 2 x 0,75 mm² esnek kablolar
- Koruma sınıfı: IP20

Ses düzeyi kontrolü potansiyometresi

Renk	
<input type="checkbox"/> beyaz	LNA5701121
<input type="checkbox"/> krem	LNA5701123

Kablo çıkışları

Özellikler

- Koruma sınıfı: IP20

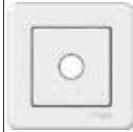



Kablo çıkışları

Renk	
<input type="checkbox"/> beyaz	LNA5500121
<input type="checkbox"/> krem	LNA5500123

Çerçeveseler

Özellikler

- Koruma sınıfı: IP20

	Tekli	İkili	Üçlü	Dörtlü
Renk				
<input type="checkbox"/> beyaz		LNA5800221	LNA5800321	LNA5800421
<input type="checkbox"/> krem		LNA5800223	LNA5800323	LNA5800423
<input type="checkbox"/> metalik bej	LNA5800124	LNA5800224	LNA5800324	LNA5800424
<input type="checkbox"/> antrasit	LNA5800125	LNA5800225	LNA5800325	LNA5800425

Anahtarlar ve liht butonlar

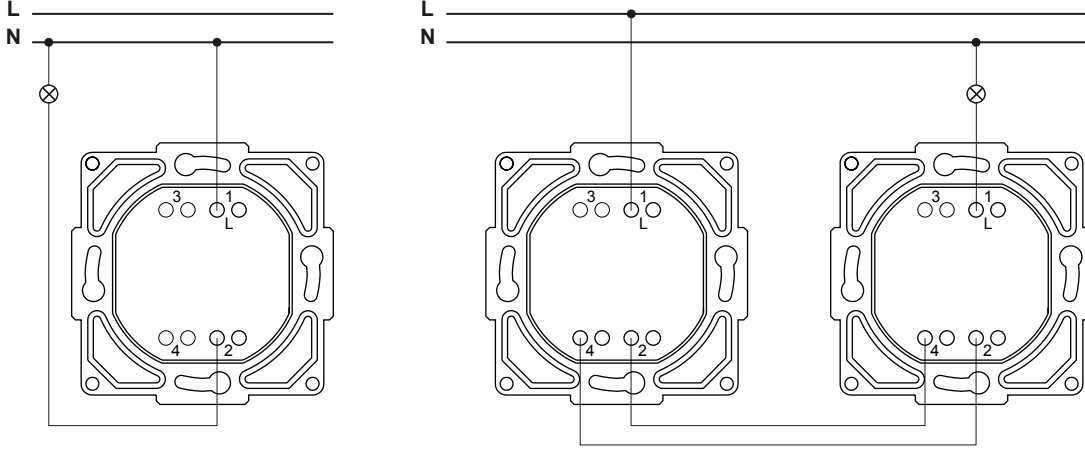

Anahtar

2 vavien

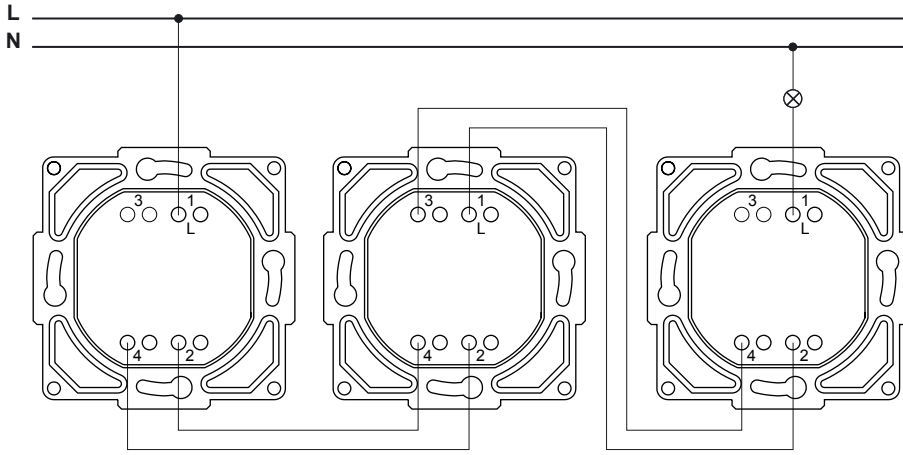

2 vavien + 1 permütatör

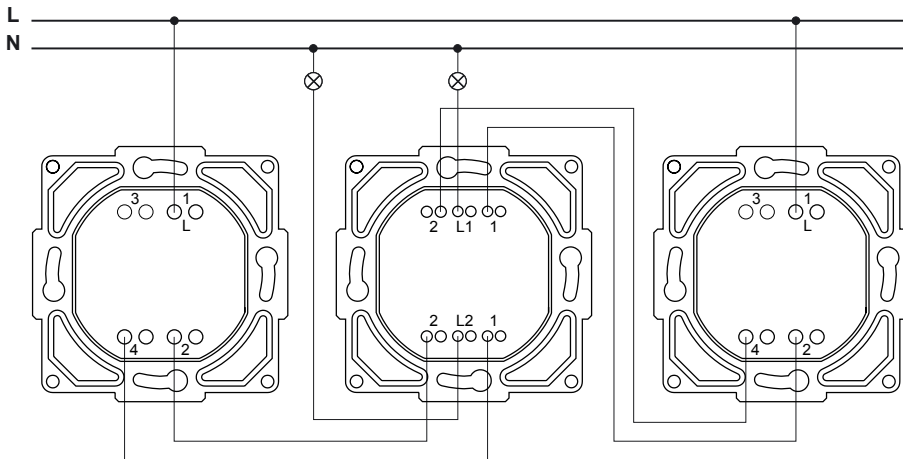

2 vavien anahtar + farklı iki yükte çalışan 1 ikili vavien

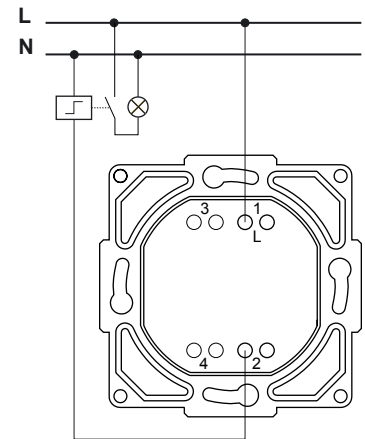

Liht buton

Işıklı anahtarlar ve liht butonlar

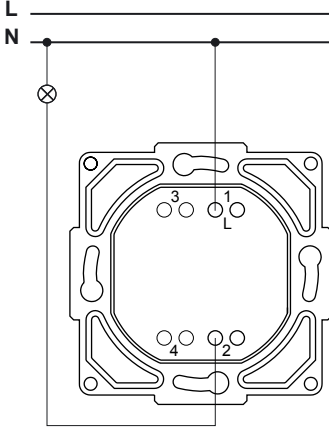

Işıklı anahtar

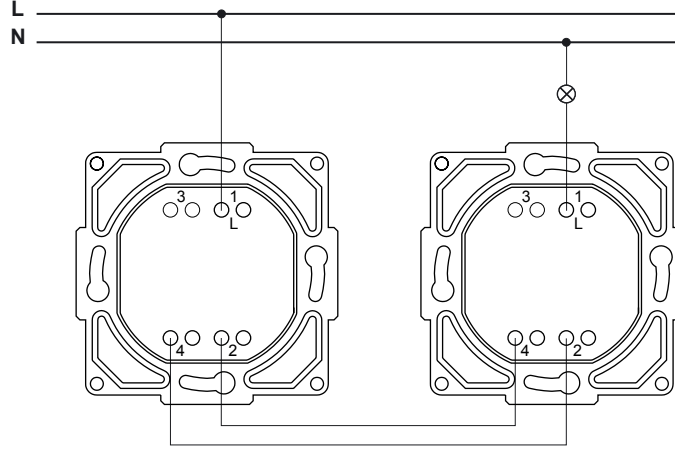

2 ışıklı vavien

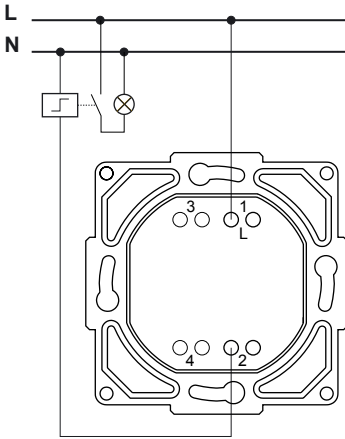

Işıklı liht buton

Dimmer

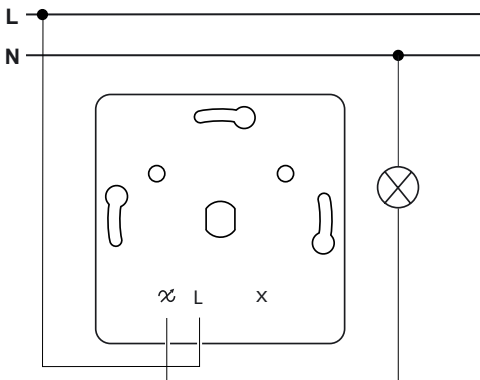

Ek parçaların derinliği

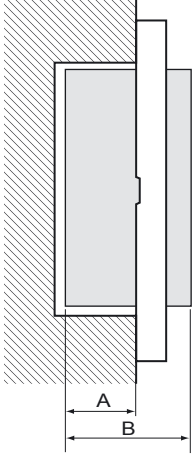

Ref.	A (mm)	B (mm)	Ref.	A (mm)	B (mm)	Ref.	A (mm)	B (mm)
LNA010032x	29,3	45,8	LNA160152x	29,3	45,8	LNA350022x	29,1	40,5
LNA030032x	29,3	45,8	LNA200032x	29,3	45,8	LNA370012x	27,1	44,2
LNA040032x	29,3	45,8	LNA210032x	27,9	44,3	LNA410012x	31,4	41,7
LNA040042x	29,3	45,8	LNA280012x	29,1	41,6	LNA420012x	27,3	37,6
LNA050032x	29,3	45,8	LNA280052x	29,4	43,61	LNA430012x	31,4	41,7
LNA060032x	27,9	44,3	LNA290012x	29,1	41,6	LNA440012x	27,3	37,6
LNA070032x	29,3	45,8	LNA290022x	29,1	41,6	LNA440112x	31,4	41,7
LNA080032x	29,3	45,8	LNA300012x	21,3	33,5	LNA470012x	31,4	41,7
LNA090032x	29,6	45,8	LNA310022x	29,1	43,7	LNA480012x	27,3	37,6
LNA130052x	27,9	44,3	LNA320012x	27,1	38,5	LNA490012x	27,3	37,6
LNA140032x	29,3	45,8	LNA330012x	29,5	39,7	LNA570112x	31,2	51,2
LNA150032x	29,3	45,8	LNA340012x	29,5	39,7	LNA640012x	31,2	51,2
LNA160032x	29,3	45,8	LNA350012x	29,1	40,5	LNA980022x	24	44,74

A: Gömme derinliği
B: Derinlik

Çerçeveler

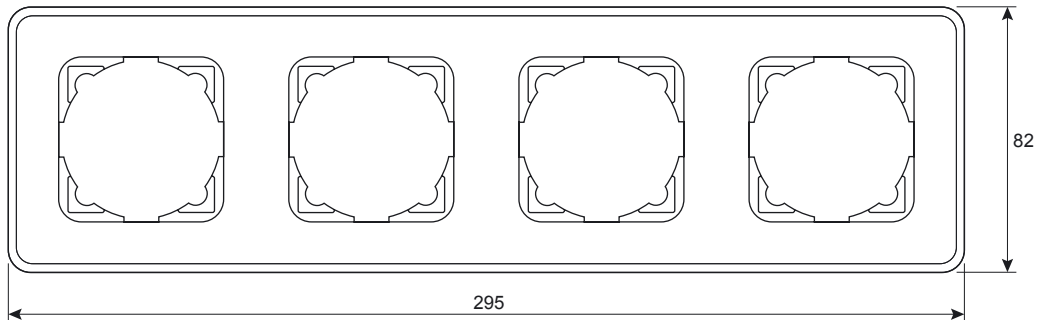
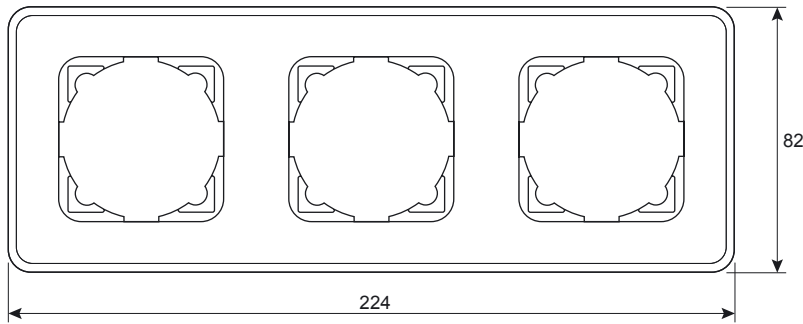
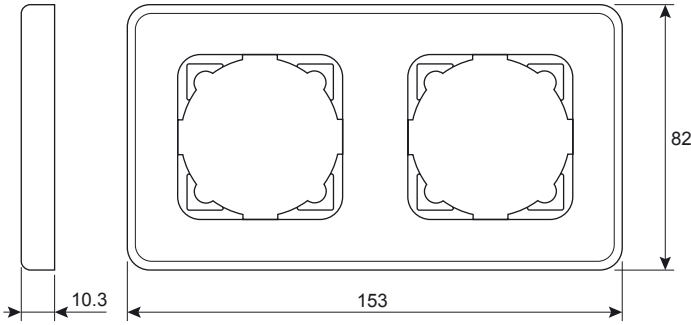

Mm olarak boyutlar.

Referanslar (sipariş kodları)

Genel bilgi

Ref.	Sayfalar	Ref.	Sayfalar	Ref.	Sayfalar	Ref.	Sayfalar	Ref.	Sayfalar
LNA010032x	14	LNA1300521	7	LNA2900123	8	LNA410012x	14	LNA5701121	10
LNA0100321	6	LNA1300523	7	LNA290022x	14	LNA4100121	9	LNA5701123	10
LNA0100323	6	LNA140032x	14	LNA2900221	8	LNA4100123	9	LNA5800221	11
LNA030032x	14	LNA1400321	6	LNA2900223	8	LNA420012x	14	LNA5800223	11
LNA0300321	6	LNA1400323	6	LNA300012x	14	LNA4200121	9	LNA5800321	11
LNA0300323	6	LNA150032x	14	LNA310022x	14	LNA4200123	9	LNA5800323	11
LNA040032x	14	LNA1500321	6	LNA3100221	8	LNA430012x	14	LNA5800421	11
LNA0400321	6	LNA1500323	6	LNA3100223	8	LNA4300121	9	LNA5800423	11
LNA0400323	6	LNA160032x	14	LNA320012x	14	LNA4301121	10	LNA640012x	14
LNA040042x	14	LNA1600321	6	LNA3200121	9	LNA4301123	10	LNA6400121	7
LNA0400421	6	LNA1600323	6	LNA3200123	9	LNA440012x	14	LNA6400123	7
LNA0400423	6	LNA160152x	14	LNA330012x	14	LNA4400121	9	LNA980022x	14
LNA050032x	14	LNA1601521	6	LNA3300121	9	LNA4400123	9	LNA9800221	8
LNA0500321	6	LNA1601523	6	LNA3300123	9	LNA440112x	14	LNA9800223	8
LNA0500323	6	LNA200032x	14	LNA340012x	14	LNA4401121	10		
LNA060032x	14	LNA2000321	6	LNA3400121	9	LNA4401123	10		
LNA0600321	6	LNA2000323	6	LNA3400123	9	LNA470012x	14		
LNA0600323	6	LNA210032x	14	LNA3400521	9	LNA4700121	9		
LNA070032x	14	LNA2100321	6	LNA3400523	9	LNA4700123	9		
LNA0700321	6	LNA2100323	6	LNA350012x	14	LNA480012x	14		
LNA0700323	6	LNA280012x	14	LNA3500121	9	LNA4800121	9		
LNA080032x	14	LNA2800121	8	LNA3500123	9	LNA4800123	9		
LNA0800321	6	LNA2800123	8	LNA350022x	14	LNA490012x	14		
LNA0800323	6	LNA2800521	8	LNA3500221	9	LNA4900121	10		
LNA090032x	14	LNA2800523	8	LNA3500223	9	LNA4900123	10		
LNA0900321	6	LNA280052x	14	LNA370012x	14	LNA5500121	11		
LNA0900323	6	LNA290012x	14	LNA3700121	9	LNA5500123	11		
LNA130052x	14	LNA2900121	8	LNA3700123	9	LNA570112x	14		

Life Is On | Schneider
Electric

Schneider Elektrik Sanayi ve Ticaret A.Ş.

Küçükbakkalköy Mah. Defne Sokak
No: 3 Büyükhaneli Plaza
34750 Ataşehir / İstanbul
Tel: +90(216) 655 88 88
Faks: +90(216) 655 87 87

se.com/tr

07-2020
ART. LSB03405TR
2020

© 2018 - Schneider Electric. All Rights Reserved.
Tüm ticari markalar, Schneider Electric Industries SAS veya bağlı şirketlerine aittir.
Belge referansı: LSB03405EN