

Asfora

2023 Katalođu



se.com/tr

Life Is On

Schneider
Electric



İçindekiler

4	Asfora sunumu
10	Anahtarlar
12	Liht butonlar
14	Prizler
16	İletişim grubu (telefon & data prizleri)
18	Dimmerler ve USB prizler
19	Aksesuarlar
21	Teknik bilgiler - Anahtarlar ve liht butonlar
22	Teknik bilgiler - Dimmerler
23	Teknik bilgiler - Anten prizleri
25	Teknik bilgiler - Sıva üstü kasalar
26	Teknik bilgiler - Boyutlar
28	Referanslar (sipariş kodları)

Asfora hayatı kolaylaştırır

Şık ve zarif tasarımlarıyla Asfora ürün grubu günümüzde bir anahtar-prizden beklenen her şeyi verir.

Yalnızca göze değil dokunma duyusuna da hitap edecek şekilde tasarlanmış olan Asfora'nın anahtar-prizleri kullanım kolaylığı ve geniş bir yelpazedeki gündelik işlevleri müşterileriniz tarafından çok beğenilecektir.



Asfora



beyaz

krem

bronz

antrasit

alüminyum

çelik

Asfora EM



beyaz

krem

bronz

antrasit

alüminyum

çelik



6'lıya kadar

Evde veya küçük ofislerde Asfora çoklu çerçeveleri, tek bir üniteye birden fazla fonksiyonla montaj sırasında kolaylık ve düzenli bir görünüm sağlayacak şekilde tasarlanmıştır.

Aydınlık ve rahatlık

Her bir odaya ve günün her saati için özel aydınlatma ambiyansları oluşturarak evlerinden mümkün olan en iyi şekilde faydalanmaları için müşterilerinize yardımcı olun.



Anahtar



Işıklı anahtar



Jaluzi anahtarı



Dimmer

Bağlanabilirlik

Müşterilerinizin dijital dünyayı avuçlarında tutmalarına yardımcı olun. Her türlü medyaya tek bir jaktan ulaşabilir ve evde tek bir kaynaktan müzik dinlemenin keyfini çıkarabilirler.



TV/R/SAT prizi



RJ45 data prizi



Hoparlör prizi

Koruma

Çocuklu ailelere enerjili parçalarla teması engelleyen çocuk korumalı prizler tavsiye edilir. Banyo ve mutfaklarda genellikle su sıçramalarına karşı IP44 ürünlerin kullanılması gereklidir.



Kapaklı priz



IP44 kapaklı priz

IP44 contalar



Islak alanlarda ve nemli koşullarda anahtarlar ve prizler sıçrama korumalı olmalarını gerekli kılan katı düzenlemelere tabidir.

Anahtarlar ve tekli prizler için yeni IP44 conta, düz ve düz olmayan yüzeylerde daha genel kullanım avantajına sahiptir. Conta ayrıca vidalı kasa alanında esnek bir şekilde kullanılabilir, böylece vidaların montaj için sökülmesine gerek kalmaz. Bu, montajı hızlı ve kolay hale getirir.



Hızlı ve kolay montaj



Genel amaçlı şekil
Düz olmayan duvarlar
için de uygundur

Kasa vida alanı
esnek
Montaj için vidaların
çıkartılması gerekli
değildir

İYİLEŞTİRİLMİŞ!

Sıçrama korumalı



Asfora IP44 conta

Anahtarlar ve tekli prizler için yeni nesil ek parçalar

Yeni ek parçalar – yeni ve geliştirilmiş özellikler!

Schneider Electric olarak geri bildirimlerinizi dikkate alıyor ve günlük iş rutininizi daha kolay ve daha verimli hale getirmek için neye ihtiyacınız olduğunu anlıyoruz. Bu nedenle Asfora grubu ek parçaların kalite ve işlevselliğinde iyileştirmeler yaptık. Güncellenmiş Asfora ürün grubunda artık daha küçük ve daha kompakt ek parçalar, metal sabitleme çerçevesi, güçlendirilmiş kablo girişleri ve hızlı bağlantı klipsleri ile dönüş yaylı, montaj tırnakları ve yayları bulunmaktadır.

YENİ!

- + kolay
- + hızlı
- + rahat

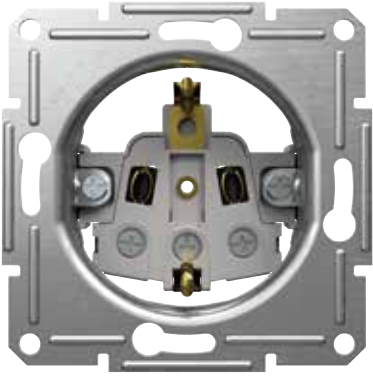

priz ek parçası

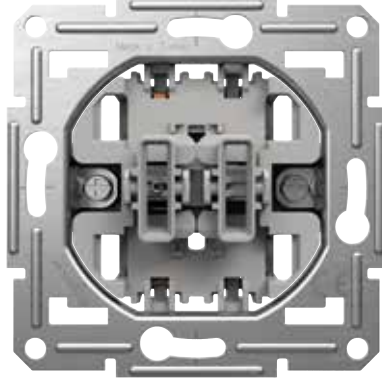

anahtar ek parçası



Asfora UPS priz



Asfora topraklı priz

Daha küçük ve daha kompakt ek parçalar

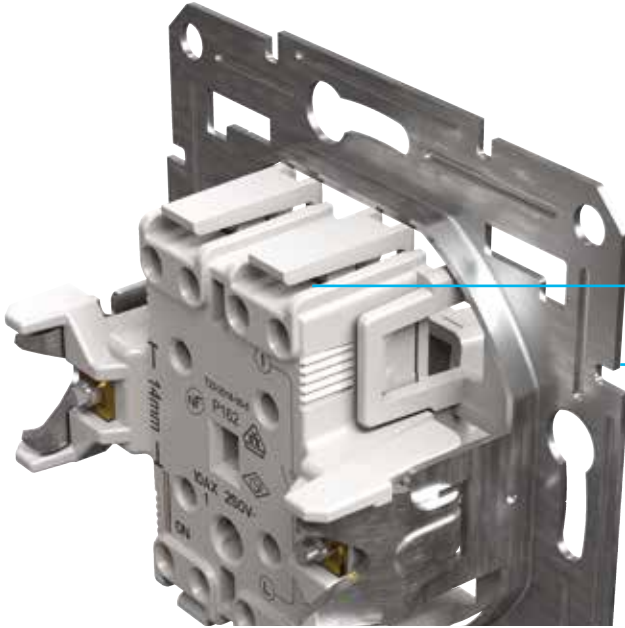

Daha küçük ve daha kompakt ek parçalar

vidalı kasalarda ek parçanın daha kolay döndürülmesini, kasadaki kabloların yönetilmesi için daha fazla alan ve kasanın iç kısmının daha iyi görülebilmesini sağlar

Yenilenmiş modül tasarımı

daha iyi kavrama için yeni dizayn metal şase

Life Is On

Schneider
Electric

Geliştirilmiş tespit çerçevesi ve tırnaklar

Basit, hızlı ve güvenli montaj

Tasarımı değiştirilmiş mekanizmaları sayesinde tırnaklar düz ve sorunsuz bir şekilde uzatılabilir ve montaj sırasında duvardaki kasalarla tam hiza sağlanır. Ayrıca ek parça kasaya güvenli bir şekilde sabitlenir.

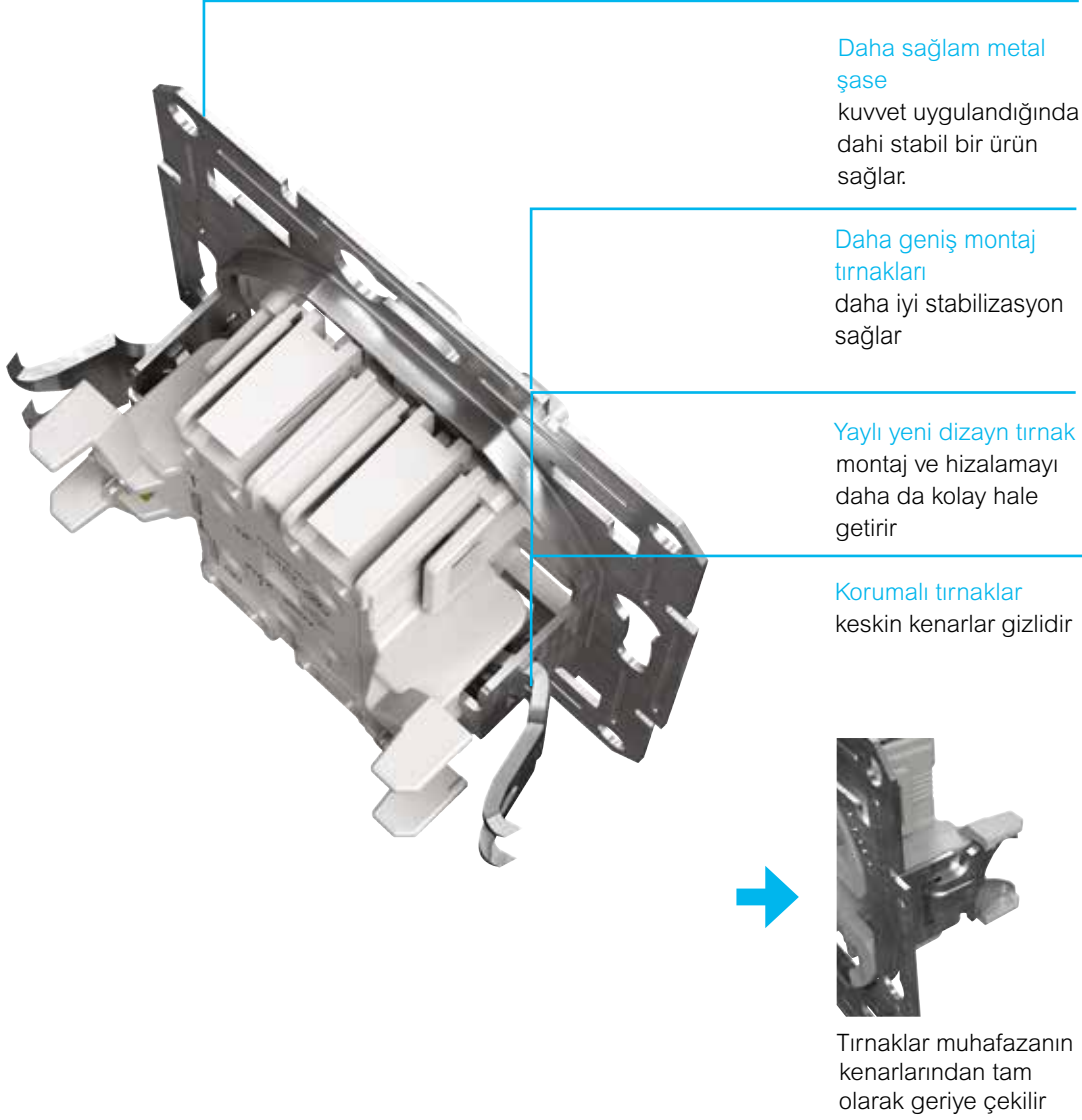

Net bağlantı şeması, anahtarlar için daha iyi kablo girişleri ve vidasız anahtarlar için şekli iyileştirilmiş klipsler

Sağladığımız yenilikçi özellikler günlük montaj iş akışınızda fark yaratacaktır.

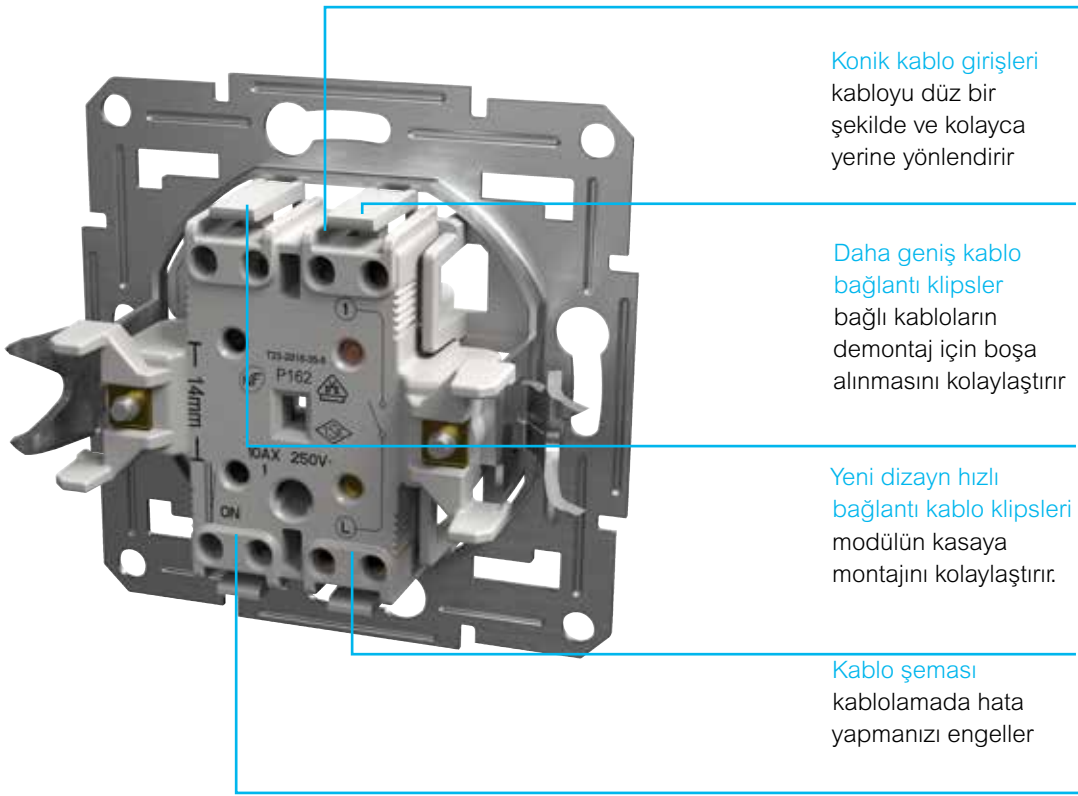

Konik kablo girişleri
kabloyu düz bir şekilde ve kolayca yerine yönlendirir

Daha geniş kablo bağlantı klipsler
bağlı kabloların demontaj için boşta alınmasını kolaylaştırır



Yeni dizayn hızlı bağlantı kablo klipsleri
modülün kasaya montajını kolaylaştırır.

Kablo şeması
kablolamada hata yapmanızı engeller

AÇIK işareti ile ürün test edilmeden daha kolay ve daha hızlı konumlandırılabilir

Asfora Anahtarlar

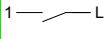
Anahtarlar - 10 AX - 250 V AC

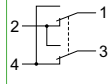
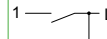
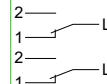
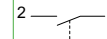
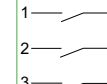
Anahtar	Vavien	Permütatör	Komütatör	2'li Vavien	Çift kutuplu anahtar	3'lü Anahtar
						

Hızlı bağlantı



Çerçevesiz

<input type="checkbox"/> beyaz	EPH0100121	EPH0400121	EPH0500121	EPH0300121	EPH0600121	EPH0200121
<input type="checkbox"/> krem	EPH0100123	EPH0400123	EPH0500123	EPH0300123	EPH0600123	EPH0200123



Çerçevesiz

<input type="checkbox"/> beyaz	EPH0170121	EPH0470121	EPH0570121	EPH0370121	EPH0670121	EPH0270121
<input type="checkbox"/> krem	EPH0170123	EPH0470123	EPH0570123	EPH0370123	EPH0670123	EPH0270123
<input type="checkbox"/> antrasit	EPH0100171	EPH0400171	EPH0500171	EPH0300171	EPH0600171	EPH0200171
<input type="checkbox"/> çelik	EPH0100162	EPH0400162	EPH0500162	EPH0300162	EPH0600162	EPH0200162
<input type="checkbox"/> alüminyum	EPH0100161	EPH0400161	EPH0500161	EPH0300161	EPH0600161	EPH0200161
<input type="checkbox"/> bronz	EPH0100169	EPH0400169	EPH0500169	EPH0300169	EPH0600169	EPH0200169

Vidalı terminaller



Çerçevesiz

<input type="checkbox"/> beyaz	EPH0100321	EPH0400321	EPH0500321	EPH0300321	EPH0600321	EPH0200321	EPH2100121
<input type="checkbox"/> krem	EPH0100323	EPH0400323	EPH0500323	EPH0300323	EPH0600323	EPH0200323	EPH2100123



Çerçevesiz

<input type="checkbox"/> beyaz							EPH2170121
<input type="checkbox"/> krem							EPH2170123
<input type="checkbox"/> antrasit	EPH0100371	EPH0400371	EPH0500371	EPH0300371	EPH0600371	EPH0200371	EPH2100171
<input type="checkbox"/> çelik	EPH0100362	EPH0400362	EPH0500362	EPH0300362	EPH0600362	EPH0200362	EPH2100162
<input type="checkbox"/> alüminyum	EPH0100361	EPH0400361	EPH0500361	EPH0300361	EPH0600361	EPH0200361	EPH2100161
<input type="checkbox"/> bronz	EPH0100369	EPH0400369	EPH0500369	EPH0300369	EPH0600369	EPH0200369	EPH2100169

Anahtarlar IP44 - 10 AX - 250 V AC

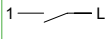
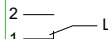
Anahtar	Vavien
	

Hızlı bağlantı



Çerçevesiz

<input type="checkbox"/> beyaz	EPH0100221	EPH0400421
<input type="checkbox"/> krem	EPH0100223	EPH0400423
<input type="checkbox"/> antrasit	EPH0100271	EPH0400471
<input type="checkbox"/> çelik	EPH0100262	EPH0400462
<input type="checkbox"/> alüminyum	EPH0100261	EPH0400461
<input type="checkbox"/> bronz	EPH0100269	EPH0400469

Özellikler

- Kendinden balastlı lambalar için maksimum yük (LED, CFL, vs.):
10 AX - 250 V AC anahtarlar: 100 W
16 AX - 250 V AC anahtarlar: 200 W

Asfora

Anahtarlar

Işıklı anahtarlar 10 AX - 250 V AC

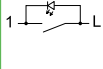
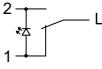
Anahtar	Vavien
	

Hızlı bağlantı



Çerçevesiz

<input type="checkbox"/> beyaz	EPH1400121	EPH1500121
<input type="checkbox"/> krem	EPH1400123	EPH1500123



Çerçevesiz

<input type="checkbox"/> beyaz	EPH1470121	EPH1570121
<input type="checkbox"/> krem	EPH1470123	EPH1570123
<input type="checkbox"/> antrasit	EPH1400171	EPH1500171
<input type="checkbox"/> çelik	EPH1400162	EPH1500162
<input type="checkbox"/> alüminyum	EPH1400161	EPH1500161
<input type="checkbox"/> bronz	EPH1400169	EPH1500169

Vidalı terminaller



Çerçevesiz

<input type="checkbox"/> beyaz	EPH1400321	EPH1500321
<input type="checkbox"/> krem	EPH1400323	EPH1500323



Çerçevesiz

<input type="checkbox"/> antrasit	EPH1400371	EPH1500371
<input type="checkbox"/> çelik	EPH1400362	EPH1500362
<input type="checkbox"/> alüminyum	EPH1400361	EPH1500361
<input type="checkbox"/> bronz	EPH1400369	EPH1500369

Işıklı anahtarlar 16 AX - 250 V AC

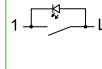
Anahtar

Vidalı terminaller



Çerçevesiz

<input type="checkbox"/> beyaz	EPH1430321
<input type="checkbox"/> krem	EPH1430323



Çerçevesiz

<input type="checkbox"/> antrasit	EPH1430371
<input type="checkbox"/> çelik	EPH1430362
<input type="checkbox"/> alüminyum	EPH1430361
<input type="checkbox"/> bronz	EPH1430369

Jaluzi anahtarları 10 A - 250 V AC

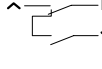

Hızlı bağlantı



Çerçevesiz

<input type="checkbox"/> beyaz	EPH1300521
<input type="checkbox"/> krem	EPH1300523



Çerçevesiz

<input type="checkbox"/> beyaz	EPH1370521
<input type="checkbox"/> krem	EPH1370523
<input type="checkbox"/> antrasit	EPH1300571
<input type="checkbox"/> çelik	EPH1300562
<input type="checkbox"/> alüminyum	EPH1300561
<input type="checkbox"/> bronz	EPH1300569

Energy saver 10 A - 250 V AC

Mekanik

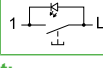

Hızlı bağlantı



Çerçevesiz

<input type="checkbox"/> beyaz	EPH6200121
<input type="checkbox"/> krem	EPH6200123



Çerçevesiz

<input type="checkbox"/> beyaz	EPH6270121
<input type="checkbox"/> krem	EPH6270123
<input type="checkbox"/> antrasit	EPH6200171
<input type="checkbox"/> çelik	EPH6200162
<input type="checkbox"/> alüminyum	EPH6200161
<input type="checkbox"/> bronz	EPH6200169

Özellikler

- Kendinden balastlı lambalar için maksimum yük (LED, CFL, vs.):
- 10 AX - 250 V AC anahtarlar: 100 W
- 16 AX - 250 V AC anahtarlar: 200 W

Life Is On

Schneider
Electric

Asfora

Liht butonlar

Liht butonlar - 10 A - 250 V AC

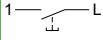
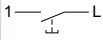
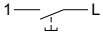
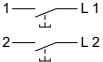
	Tek Liht buton	Zil işaretli liht buton	Işık işaretli liht buton	Çift 2'li liht buton
				

Hızlı bağlantı



Çerçevesiz

<input type="checkbox"/> beyaz	EPH0700121	EPH0800121	EPH0900121	EPH1100121
<input type="checkbox"/> krem	EPH0700123	EPH0800123	EPH0900123	EPH1100123



Çerçevesiz

<input type="checkbox"/> beyaz	EPH0770121	EPH0870121	EPH0970121	EPH1170121
<input type="checkbox"/> krem	EPH0770123	EPH0870123	EPH0970123	EPH1170123
<input type="checkbox"/> antrasit	EPH0700171	EPH0800171	EPH0900171	EPH1100171
<input type="checkbox"/> çelik	EPH0700162	EPH0800162	EPH0900162	EPH1100162
<input type="checkbox"/> alüminyum	EPH0700161	EPH0800161	EPH0900161	EPH1100161
<input type="checkbox"/> bronz	EPH0700169	EPH0800169	EPH0900169	EPH1100169

Vidalı terminaller



Çerçevesiz

<input type="checkbox"/> beyaz	EPH0800321			EPH1100321
<input type="checkbox"/> krem	EPH0800323			EPH1100323



Çerçevesiz

<input type="checkbox"/> antrasit	EPH0800371			EPH1100371
<input type="checkbox"/> çelik	EPH0800362			EPH1100362
<input type="checkbox"/> alüminyum	EPH0800361			EPH1100361
<input type="checkbox"/> bronz	EPH0800369			EPH1100369

Asfora

Liht butonlar

Işıklı liht butonlar 10 A - 250 V AC

Liht buton	Zil işaretli liht buton	Işık işaretli liht buton	Merdiven işaretli liht buton

Hızlı bağlantı



Çerçevesi

<input type="checkbox"/> beyaz	EPH1600121	EPH1700121	EPH1800121	EPH1900121
<input type="checkbox"/> krem	EPH1600123	EPH1700123	EPH1800123	EPH1900123



Çerçevesiz

<input type="checkbox"/> beyaz	EPH1670121	EPH1770121	EPH1870121	EPH1970121
<input type="checkbox"/> krem	EPH1670123	EPH1770123	EPH1870123	
<input type="checkbox"/> antrasit	EPH1600171		EPH1800171	EPH1900171
<input type="checkbox"/> çelik	EPH1600162		EPH1800162	EPH1900162
<input type="checkbox"/> alüminyum	EPH1600161		EPH1800161	EPH1900161
<input type="checkbox"/> bronz	EPH1600169		EPH1800169	EPH1900169

Vidalı terminaller



Çerçevesi

<input type="checkbox"/> beyaz	EPH1600321	EPH1700321		EPH1900321
<input type="checkbox"/> krem	EPH1600323	EPH1700323		EPH1900323



Çerçevesiz

<input type="checkbox"/> antrasit	EPH1600371	EPH1700371		EPH1900371
<input type="checkbox"/> çelik	EPH1600362	EPH1700362		EPH1900362
<input type="checkbox"/> alüminyum	EPH1600361	EPH1700361		EPH1900361
<input type="checkbox"/> bronz	EPH1600369	EPH1700369		EPH1900369

Jaluzi liht buton 10 A - 250 V AC

--

Hızlı bağlantı



Çerçevesi

<input type="checkbox"/> beyaz	EPH1300121
<input type="checkbox"/> krem	EPH1300123



Çerçevesiz

<input type="checkbox"/> beyaz	EPH1370121
<input type="checkbox"/> krem	EPH1370123
<input type="checkbox"/> antrasit	EPH1300171
<input type="checkbox"/> çelik	EPH1300162
<input type="checkbox"/> alüminyum	EPH1300161
<input type="checkbox"/> bronz	EPH1300169

Vidalı terminaller



Çerçevesi

<input type="checkbox"/> beyaz	EPH1300321
<input type="checkbox"/> krem	EPH1300323



Çerçevesiz

<input type="checkbox"/> antrasit	EPH1300371
<input type="checkbox"/> çelik	EPH1300362
<input type="checkbox"/> alüminyum	EPH1300361
<input type="checkbox"/> bronz	EPH1300369

Liht butonlar - ışıklı ve etiket tutuculu 12 V AC

1 yönlü

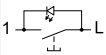

Hızlı bağlantı



Çerçevesi

<input type="checkbox"/> beyaz	EPH1601521
<input type="checkbox"/> krem	EPH1601523

Prizler - 2P - 16 A - 250 V AC

	Tek	İkili ^[*]	İkili PL standardı ^[*]
Hızlı bağlantı			
			
Çerçevesiz			
<input type="checkbox"/> beyaz	EPH3000121	EPH9700121 ^[*]	EPH9700221 ^[*]
<input type="checkbox"/> krem	EPH3000123	EPH9700123 ^[*]	EPH9700223 ^[*]
<input type="checkbox"/> antrasit		EPH9700171 ^[*]	EPH9700271 ^[*]
<input type="checkbox"/> çelik		EPH9700162 ^[*]	EPH9700262 ^[*]
<input type="checkbox"/> alüminyum		EPH9700161 ^[*]	EPH9700261 ^[*]
<input type="checkbox"/> bronz		EPH9700169 ^[*]	EPH9700269 ^[*]
			
Çerçevesiz			
<input type="checkbox"/> antrasit	EPH3000171		
<input type="checkbox"/> çelik	EPH3000162		
<input type="checkbox"/> alüminyum	EPH3000161		
<input type="checkbox"/> bronz	EPH3000169		







[*] Çerçeve sistemiyle uyumlu değildir.

UPS prizler - 2P+E - 16 A - 250 V AC

	Tek	Çocuk korumalı tek	Çocuk korumalı ve IP44 kapaklı tek	Çocuk korumalı ve IP44 kapaklı tek ^[*]	Kırmızı göbekli tek	İkili CZ, SK standartları ^[*]	İkili PL standardı
Vidalı terminaller							
							
Çerçevesiz							
<input type="checkbox"/> beyaz	EPH2800121	EPH2800221	EPH2800621	EPH2800321 ^[*]	EPH2800421	EPH9800121 ^[*]	EPH9800221 ^[*]
<input type="checkbox"/> krem	EPH2800123	EPH2800223	EPH2800623	EPH2800323 ^[*]	EPH2800423	EPH9800123 ^[*]	EPH9800223 ^[*]
<input type="checkbox"/> antrasit				EPH2800371 ^[*]		EPH9800171 ^[*]	EPH9800271 ^[*]
<input type="checkbox"/> çelik				EPH2800362 ^[*]		EPH9800162 ^[*]	EPH9800262 ^[*]
<input type="checkbox"/> alüminyum				EPH2800361 ^[*]		EPH9800161 ^[*]	EPH9800261 ^[*]
<input type="checkbox"/> bronz				EPH2800369 ^[*]		EPH9800169 ^[*]	EPH9800269 ^[*]
							
Çerçevesiz							
<input type="checkbox"/> beyaz	EPH2870121						EPH9810221
<input type="checkbox"/> krem	EPH2870123						EPH9810223
<input type="checkbox"/> antrasit	EPH2800171	EPH2800271	EPH2800671				EPH9810271
<input type="checkbox"/> çelik	EPH2800162	EPH2800262	EPH2800662				EPH9810262
<input type="checkbox"/> alüminyum	EPH2800161	EPH2800261	EPH2800661				EPH9810261
<input type="checkbox"/> bronz	EPH2800169	EPH2800269	EPH2800669				EPH9810269
<input type="checkbox"/> kırmızı	EPH2870442						

[*] Çerçeve sistemiyle uyumlu değildir.

Topraklı prizler - 2P+E - 16 A - 250 V AC

	Tek	Çocuk korumalı tek	Kapaklı tek	Çocuk korumalı ve IP44 kapaklı tek ^[*]	Çocuk korumalı ve kırmızı göbekli tek	İkili ^[*]
Vidalı terminaller						
						
Çerçevesiz						
<input type="checkbox"/> beyaz	EPH2900121	EPH2900221	EPH3100121	EPH3100321 ^[*]	EPH2900521	EPH9900121 ^[*]
<input type="checkbox"/> krem	EPH2900123	EPH2900223	EPH3100123	EPH3100323 ^[*]	EPH2900523	EPH9900123 ^[*]
<input type="checkbox"/> antrasit				EPH3100371 ^[*]		EPH9900171 ^[*]
<input type="checkbox"/> çelik				EPH3100362 ^[*]		EPH9900162 ^[*]
<input type="checkbox"/> alüminyum				EPH3100361 ^[*]		EPH9900161 ^[*]
<input type="checkbox"/> bronz				EPH3100369 ^[*]		EPH9900169 ^[*]
						
Çerçevesiz						
<input type="checkbox"/> beyaz	EPH2970121	EPH2970221	EPH3170121			
<input type="checkbox"/> krem	EPH2970123	EPH2970223	EPH3170123			
<input type="checkbox"/> antrasit	EPH2900171	EPH2900271	EPH3100171			
<input type="checkbox"/> çelik	EPH2900162	EPH2900262	EPH3100162			
<input type="checkbox"/> alüminyum	EPH2900161	EPH2900261	EPH3100161			
<input type="checkbox"/> bronz	EPH2900169	EPH2900269	EPH3100169			

[*] Çerçeve sistemiyle uyumlu değildir.

Kablo çıkışları

Vidalı terminaller



Çerçevesiz

<input type="checkbox"/> beyaz	EPH5500121
<input type="checkbox"/> krem	EPH5500123



Çerçevesiz

<input type="checkbox"/> beyaz	
<input type="checkbox"/> krem	
<input type="checkbox"/> antrasit	EPH5500171
<input type="checkbox"/> çelik	EPH5500162
<input type="checkbox"/> alüminyum	EPH5500161
<input type="checkbox"/> bronz	EPH5500169

Anten prizleri











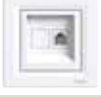
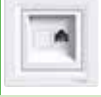





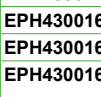
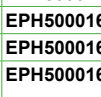
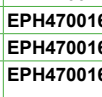
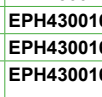

	Sonlu (1 dB)					
	TV	TV-R	TV-SAT	TV-R-SAT	TV-SAT-SAT	SAT
Konnektör tipi	IEC Erkek	IEC Erkek + Dişi	IEC Erkek + F	IEC Erkek + Dişi + F	IEC Erkek + F + F	F
Çerçevesi						
<input type="checkbox"/> beyaz	EPH3200121	EPH3300121	EPH3400121	EPH3500121	EPH3600121	EPH3700121
<input type="checkbox"/> krem	EPH3200123	EPH3300123	EPH3400123	EPH3500123	EPH3600123	EPH3700123
Çerçevesiz						
<input type="checkbox"/> beyaz	EPH3270121	EPH3300721	EPH3470121		EPH3670121	EPH3770121
<input type="checkbox"/> krem	EPH3270123	EPH3300723	EPH3470123		EPH3670123	EPH3770123
<input type="checkbox"/> antrasit	EPH3200171	EPH3300171	EPH3400171	EPH3500171	EPH3600171	EPH3700171
<input type="checkbox"/> çelik	EPH3200162	EPH3300162	EPH3400162	EPH3500162	EPH3600162	EPH3700162
<input type="checkbox"/> alüminyum	EPH3200161	EPH3300161	EPH3400161	EPH3500161	EPH3600161	EPH3700161
<input type="checkbox"/> bronz	EPH3200169	EPH3300169	EPH3400169	EPH3500169	EPH3600169	EPH3700169

	Bağımsız (1 dB)	
	Konnektör tipi	TV-SAT
	IEC Erkek + F	
Çerçevesi		
<input type="checkbox"/> beyaz	EPH3400421	
<input type="checkbox"/> krem	EPH3400423	
Çerçevesiz		
<input type="checkbox"/> antrasit	EPH3400471	
<input type="checkbox"/> çelik	EPH3400462	
<input type="checkbox"/> alüminyum	EPH3400461	
<input type="checkbox"/> bronz	EPH3400469	

	Geçişli (4 dB)					
	TV	TV-R	TV-SAT	TV-R-SAT		SAT
Çerçevesi						
<input type="checkbox"/> beyaz	EPH3200221	EPH3300221	EPH3400221	EPH3500221		EPH3700221
<input type="checkbox"/> krem	EPH3200223	EPH3300223	EPH3400223	EPH3500223		EPH3700223
Çerçevesiz						
<input type="checkbox"/> antrasit	EPH3200271	EPH3300271	EPH3400271	EPH3500271		EPH3700271
<input type="checkbox"/> çelik	EPH3200262	EPH3300262	EPH3400262	EPH3500262		EPH3700262
<input type="checkbox"/> alüminyum	EPH3200261	EPH3300261	EPH3400261	EPH3500261		EPH3700261
<input type="checkbox"/> bronz	EPH3200269	EPH3300269	EPH3400269	EPH3500269		EPH3700269

	Geçişli (8 dB)			
	TV	TV-R	TV-SAT	TV-R-SAT
Çerçevesi				
<input type="checkbox"/> beyaz	EPH3200321	EPH3300321	EPH3400321	EPH3500321
<input type="checkbox"/> krem	EPH3200323	EPH3300323	EPH3400323	EPH3500323
Çerçevesiz				
<input type="checkbox"/> beyaz	EPH3270321		EPH3470321	
<input type="checkbox"/> krem	EPH3270323		EPH3470323	
<input type="checkbox"/> antrasit	EPH3200371	EPH3300371	EPH3400371	EPH3500371
<input type="checkbox"/> çelik	EPH3200362	EPH3300362	EPH3400362	EPH3500362
<input type="checkbox"/> alüminyum	EPH3200361	EPH3300361	EPH3400361	EPH3500361
<input type="checkbox"/> bronz	EPH3200369	EPH3300369	EPH3400369	EPH3500369

Data ve telefon prizleri

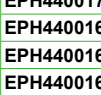
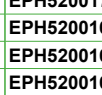
	Tek RJ11	RJ45 Cat.5e UTP	RJ45 Cat.5e STP	RJ45 Cat.6 UTP	RJ45 Boş
Terminaller	Vida	IDC	IDC	IDC	
					
Çerçevesi					
<input type="checkbox"/> beyaz	EPH4100121	EPH4300121	EPH5000121	EPH4700121	EPH4370521
<input type="checkbox"/> krem	EPH4100123	EPH4300123	EPH5000123	EPH4700123	EPH4370523
					
Çerçevesiz					
<input type="checkbox"/> beyaz	EPH4170121	EPH4370121		EPH4770121	
<input type="checkbox"/> krem	EPH4170123	EPH4370123		EPH4770123	
<input type="checkbox"/> antrasit	EPH4100171	EPH4300171	EPH5000171	EPH4700171	EPH4300171-02
<input type="checkbox"/> çelik	EPH4100162	EPH4300162	EPH5000162	EPH4700162	EPH4300162-02
<input type="checkbox"/> alüminyum	EPH4100161	EPH4300161	EPH5000161	EPH4700161	EPH4300161-02
<input type="checkbox"/> bronz	EPH4100169	EPH4300169	EPH5000169	EPH4700169	EPH4300169-02
					
Çift RJ11	RJ45 Cat.5e UTP	RJ45 Boş	RJ45 Cat.6 UTP	RJ45 + RJ11 Cat.6 UTP	RJ45 + RJ12 Cat.5e UTP
Terminaller	Vida	IDC	IDC	IDC - Vida	IDC
					
Çerçevesi					
<input type="checkbox"/> beyaz	EPH4200121	EPH4400121	EPH4470521	EPH4800121	EPH5200121
<input type="checkbox"/> krem	EPH4200123	EPH4400123	EPH4470523	EPH4800123	EPH5200123
					
Çerçevesiz					
<input type="checkbox"/> beyaz	EPH4270121	EPH4470121		EPH4870121	EPH5270121
<input type="checkbox"/> krem	EPH4270123	EPH4470123		EPH4870123	EPH5270123
<input type="checkbox"/> antrasit	EPH4200171	EPH4400171	EPH4300171-02	EPH4800171	EPH5200171
<input type="checkbox"/> çelik	EPH4200162	EPH4400162	EPH4300162-02	EPH4800162	EPH5200162
<input type="checkbox"/> alüminyum	EPH4200161	EPH4400161	EPH4300161-02	EPH4800161	EPH5200161
<input type="checkbox"/> bronz	EPH4200169	EPH4400169	EPH4300169-02	EPH4800169	EPH5200169
					

Hoparlör prizleri

İkili hoparlör çıkışı
Hızlı bağlantı



Çerçevesi

beyaz EPH5700121
 krem EPH5700123



Çerçevesiz

beyaz EPH5770121
 krem EPH5770123
 antrasit EPH5700171
 çelik EPH5700162
 alüminyum EPH5700161
 bronz EPH5700169

Ses potansiyometresi

Hızlı bağlantı



Çerçevesi



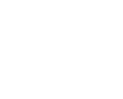







beyaz EPH5401121
 krem EPH5401123



Çerçevesiz





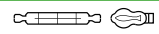
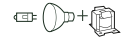
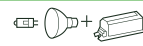

beyaz
 krem
 antrasit EPH5401171
 çelik EPH5401162
 alüminyum EPH5401161
 bronz EPH5401169

Dimmerler - 230 V AC

	600 VA, vavien	600 VA, ışıklı vavien ⁽¹⁾	315 VA, vavien	RC ⁽¹⁾ 0-370 W	
	Vidalı terminaler (sütun tipi)				
					
	Çerçevesi				
<input type="checkbox"/> beyaz	EPH6400121	EPH6500121	EPH6600121	EPH6800121	
<input type="checkbox"/> krem	EPH6400123	EPH6500123	EPH6600123	EPH6800123	
					
	Çerçevesiz				
<input type="checkbox"/> beyaz	EPH6470121	EPH6570121	EPH6670121	EPH6870121	
<input type="checkbox"/> krem	EPH6470123	EPH6570123	EPH6670123	EPH6870123	
<input type="checkbox"/> antrasit	EPH6400171	EPH6500171	EPH6600171	EPH6800171	
<input type="checkbox"/> çelik	EPH6400162	EPH6500162	EPH6600162	EPH6800162	
<input type="checkbox"/> alüminyum	EPH6400161	EPH6500161	EPH6600161	EPH6800161	
<input type="checkbox"/> bronz	EPH6400169	EPH6500169	EPH6600169	EPH6800169	
Diğer özellikler				Topraksız	Topraklı
Kısa devre koruması	Sigorta F6, 3 AH - 250 V		Elektronik		
Yükler					
LED lamp 230 V 				3...200 W (max. 1.3 A)	0...200 W (max. 1.3 A)
230 V AC akkor lambalar 	40-600 W	40-600 W	20-315 W	3...370 W	0...370 W
230 V AC halojen lambalar 	40-600 W	40-600 W	20-315 W	3...370 W	0...370 W
Ferromanyetik transformatörlü LV halojen lambalar 	40-600 VA	40-600 VA	-		
Elektronik transformatörlü LV halojen lambalar 	-	-	20-315 VA	3...370 W	0...370 W







(1) Işık döner kontrol düğmesinin altındadır.

USB prizler



	İkili USB şarj prizi tip A, 2.1 A veya 2 x 1.05 A	İkili USB şarj prizi tip A + C, 2.4 A veya 2 x 1.2 A	İkili USB şarj prizi tip A+C, 45W, 3A
			
	Çerçevesi		
<input type="checkbox"/> beyaz	EPH2700221	EPH2700321	EPH2700421
<input type="checkbox"/> krem	EPH2700223	EPH2700323	
			
	Çerçevesiz		
<input type="checkbox"/> antrasit	EPH2700271	EPH2700371	EPH2700471
<input type="checkbox"/> çelik	EPH2700262	EPH2700362	
<input type="checkbox"/> alüminyum	EPH2700261	EPH2700361	
<input type="checkbox"/> bronz	EPH2700269	EPH2700369	

Asfora Aksesuarlar



Çerçeveler - Asfora

	Tekli	İkili	Üçlü	Dörtlü	Beşli	Altılı
Yatay						
<input type="checkbox"/> beyaz	EPH5800121	EPH5800221	EPH5800321	EPH5800421	EPH5800521	EPH5800621
<input type="checkbox"/> krem	EPH5800123	EPH5800223	EPH5800323	EPH5800423	EPH5800523	EPH5800623
<input type="checkbox"/> antrasit	EPH5800171	EPH5800271	EPH5800371	EPH5800471	EPH5800571	EPH5800671
<input type="checkbox"/> çelik	EPH5800162	EPH5800262	EPH5800362	EPH5800462	EPH5800562	EPH5800662
<input type="checkbox"/> alüminyum	EPH5800161	EPH5800261	EPH5800361	EPH5800461	EPH5800561	EPH5800661
<input type="checkbox"/> bronz	EPH5800169	EPH5800269	EPH5800369	EPH5800469	EPH5800569	EPH5800669



Dikey

	İkili	Üçlü
		
<input type="checkbox"/> beyaz	EPH5810221	EPH5810321
<input type="checkbox"/> krem	EPH5810223	EPH5810323
<input type="checkbox"/> antrasit	EPH5810271	EPH5810371
<input type="checkbox"/> çelik	EPH5810262	EPH5810362
<input type="checkbox"/> alüminyum	EPH5810261	EPH5810361
<input type="checkbox"/> bronz	EPH5810269	EPH5810369

Sıva üstü kasalar

	Tekli	Çoklu uzatma
Hızlı bağlantı ve vidalı terminaller		
<input type="checkbox"/> beyaz	EPH6100121	EPH6100221
<input type="checkbox"/> krem	EPH6100123	EPH6100223
<input type="checkbox"/> antrasit	EPH6100171	EPH6100271
<input type="checkbox"/> çelik	EPH6100162	EPH6100262
<input type="checkbox"/> alüminyum	EPH6100161	EPH6100261
<input type="checkbox"/> bronz	EPH6100169	EPH6100269





Kör kapaklar



	Çerçevesiz
	
Çerçevesiz	
<input type="checkbox"/> beyaz	EPH5600121
<input type="checkbox"/> krem	EPH5600123
	
Çerçevesiz	
<input type="checkbox"/> beyaz	EPH5670121
<input type="checkbox"/> krem	EPH5670123
<input type="checkbox"/> antrasit	EPH5600171
<input type="checkbox"/> çelik	EPH5600162
<input type="checkbox"/> alüminyum	EPH5600161
<input type="checkbox"/> bronz	EPH5600169

Asfora EM

Aksesuarlar

Çerçeveler - Asfora EM

	Tekli	İkili	Üçlü	Dörtlü	Beşli
Yatay					
<input type="checkbox"/> beyaz	EPH5805121	EPH5805221	EPH5805321	EPH5805421	EPH5805521
<input type="checkbox"/> krem	EPH5805123	EPH5805223	EPH5805323	EPH5805423	EPH5805523
<input type="checkbox"/> antrasit	EPH5805171	EPH5805271	EPH5805371	EPH5805471	EPH5805571
<input type="checkbox"/> çelik	EPH5805162	EPH5805262	EPH5805362	EPH5805462	EPH5805562
<input type="checkbox"/> alüminyum	EPH5805161	EPH5805261	EPH5805361	EPH5805461	EPH5805561
<input type="checkbox"/> bronz	EPH5805169	EPH5805269	EPH5805369	EPH5805469	EPH5805569

	İkili	Üçlü
Dikey		
<input type="checkbox"/> beyaz	EPH5815221	EPH5815321
<input type="checkbox"/> krem	EPH5815223	EPH5815323
<input type="checkbox"/> antrasit	EPH5815271	EPH5815371
<input type="checkbox"/> çelik	EPH5815262	EPH5815362
<input type="checkbox"/> alüminyum	EPH5815261	EPH5815361
<input type="checkbox"/> bronz	EPH5815269	EPH5815369

Not:

Asfora EM çerçeveler, aşağıdaki Asfora referans kodlu mekanizmalara oturmamaktadır:

- Topraklı priz IP44: EPH31001xx, EPH31003xx, EPH31701xx
- UPS priz IP44: EPH28003xx, EPH28006xx
- PL standardı ikili priz: EPH98102xx
- Energy saver: EPH62001xx, EPH62701xx
- Sıva-üstü montaj kasaları: EPH61001xx, EPH61002xx

Bağlantı Örnekleri

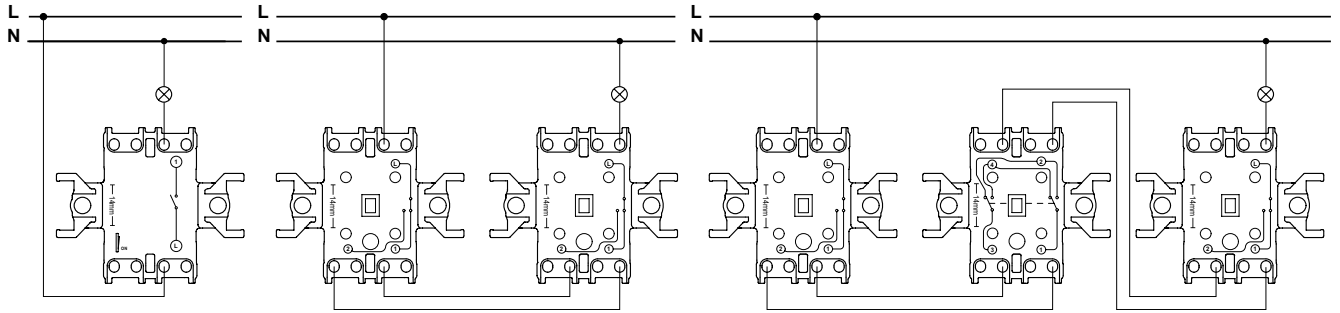

1 anahtar

İki vavien anahtar

2 vavien anahtar + 1 permütatör

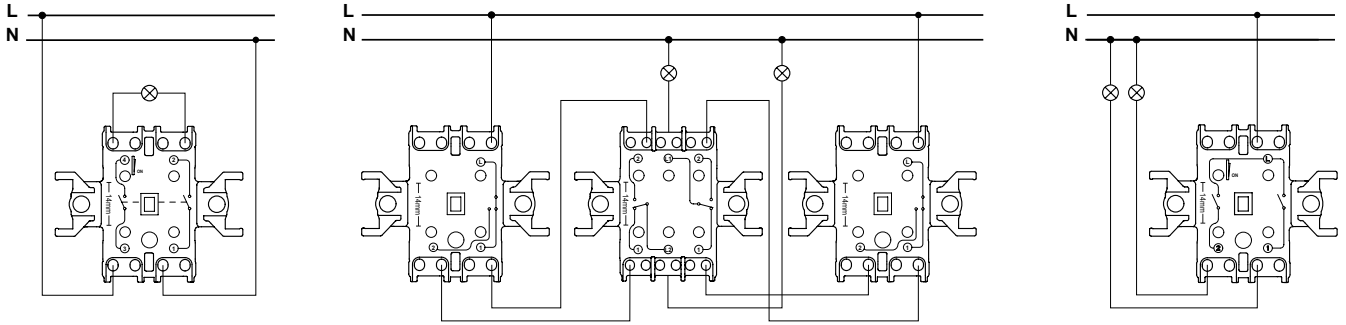

Çift kutuplu anahtar

2 vavien anahtar + iki farklı yükte çalışan 1 ikili vavien

Komütatör

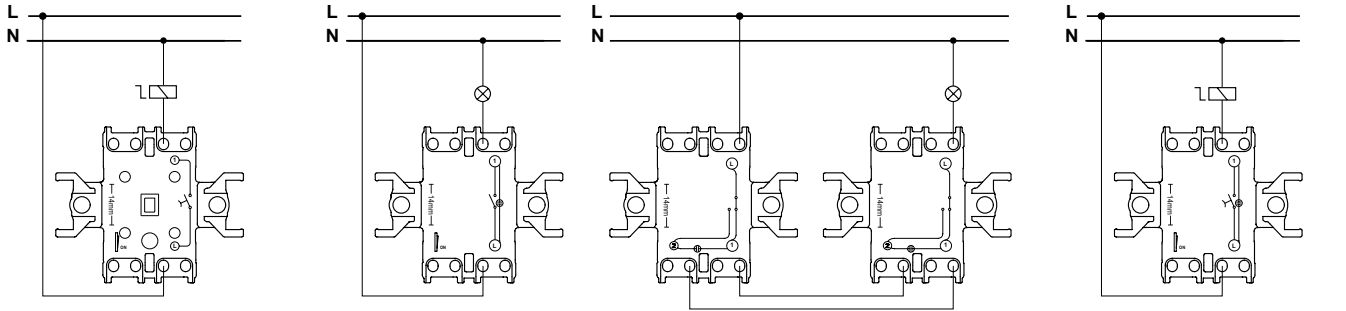

Liht buton

İşıklı anahtar

İşıklı 2 vavien

İşıklı liht buton

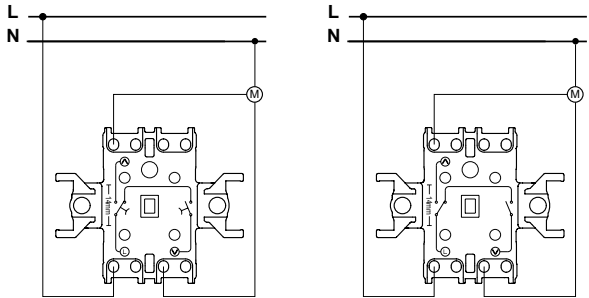

Jaluzi liht buton

Jaluzi anahtar

Teknik bilgiler

Dimmerler

Elektronik dimmer

Kurulum

Cihaz tek ve standart gömme montaj kasaına monte edilmemişse azalan ısı yayılımını nedeniyle izin verilen maksimum yük azaltılmalıdır.

Yük azaltma katsayısı	Boşluklu duvarlara monte edilir ⁽¹⁾	Birkaç tane birlikte monte edilebilir ⁽¹⁾	Tekli veya ikili sıva üstü muhafazada	Üçlü sıva üstü muhafazada
%25	■	■		
%30			■	
%50				■

(1) Birden fazla etken söz konusudur, yük azaltmaları toplayın.

Bağlantılar

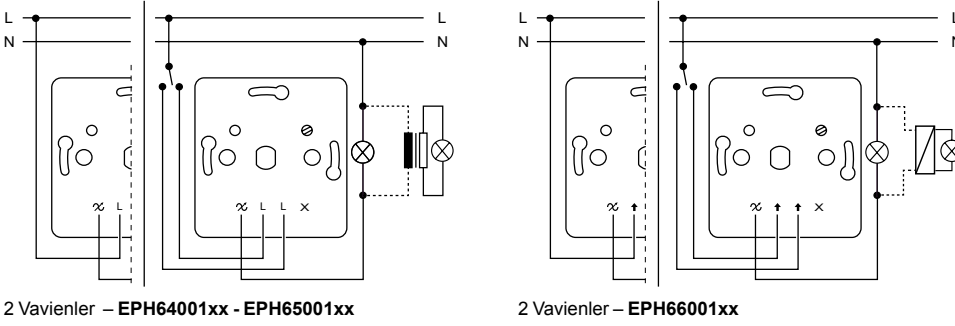

Değiştirme örnekleri

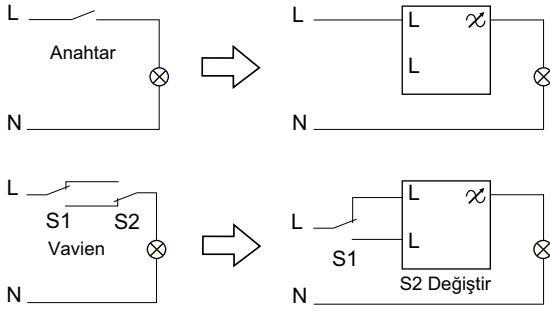

Asfora

Teknik bilgiler

Anten prizleri

Tip	TV			TV-R			
	Sonlu 1 dB	Geçişli 4 dB	Geçişli 8 dB	Sonlu 1 dB	Geçişli 4 dB	Geçişli 8 dB	
	EPH32001xx EPH32701xx	EPH32002xx	EPH32003xx EPH32703xx	EPH33001xx EPH33007xx	EPH33002xx	EPH33003xx	
Kayıp	dB	1	4	8	1	4	8
Çalışma Frekansı	SAT	MHz	-	-	-	-	-
	TV/VHF		5-862	5-862	5-862	118-470	118-470
	TV/UHF		5-862	5-862	5-862	470-830	470-830
	R		-	-	-	10-108	10-108
Geçiş zayıflama	SAT	dB	-	-	-	-	-
	TV/VHF		1	4	8	1,5	3,7
	TV/UHF		1	4	8	2,8	4,6
	R		-	-	-	11,1	9,3
Çıkış kaybı	dB	-	4	8	-	0,5	0,5
DC Akım		-	-	-	-	-	-
Çıkışlar/hat		-	-	-	1	4	4

Tip	TV-SAT				TV-R-SAT		
	Sonlu 1 db	Geçişli 4 dB	Geçişli 8 dB	Bağımsız 1 dB	Sonlu 1 db	Geçişli 4 dB	Geçişli 8 dB
	EPH34001xx EPH34701xx	EPH34002xx	EPH34003xx EPH34703xx	EPH34004xx	EPH35001xx	EPH35002xx	EPH35003xx
Kayıp	dB	1	4	8	1	4	8
Çalışma Frekansı	SAT	MHz	950-2400	950-2400	950-2400	950-2400	950-2400
	TV/VHF		118-470	118-470	118-470	118-470	118-470
	TV/UHF		470-830	470-830	470-830	470-830	470-830
	R		-	-	-	10-108	10-108
Geçiş zayıflama	SAT	dB	13	12,1	10,3	13	4,1
	TV/VHF		2,2	4,5	10,8	2,2	1,5
	TV/UHF		1	4,8	12,3	1	2,7
	R		-	-	-	14,8	16,8
Çıkış kaybı	dB	-	0,5	0,5	-	0,5	0,5
DC Akım		SAT çıkışında	SAT çıkışında	SAT çıkışında	SAT çıkışında	SAT çıkışında	SAT çıkışında
Çıkışlar/hat		1	4	4	1	4	4

Tip	TV-SAT-SAT		SAT
	Sonlu 1 dB	Sonlu 1 db	Geçişli 4 dB
	EPH36001xx EPH36701xx	EPH37001xx EPH37701xx	EPH37002xx
Kayıp	dB	1	4
Çalışma Frekansı	SAT	MHz	950-2400
	TV/VHF		118-470
	TV/UHF		470-830
	R		10-108
Geçiş zayıflama	SAT	dB	13
	TV/VHF		2,2
	TV/UHF		1
	R		-
Çıkış kaybı	dB	-	0,5
DC Akım		SAT çıkışında	SAT çıkışında
Çıkışlar/hat		1	4

"Sonlu TV / R çıkışı" soketlerinden yalnızca biri bağımsız olarak kullanılabilir.
Yalnızca "Bağımsız TV / SAT çıkışı" kablo bağlantılı soketi lineer kurulumda sonlandırma olarak kullanılabilir.

TV/R uygulamaları

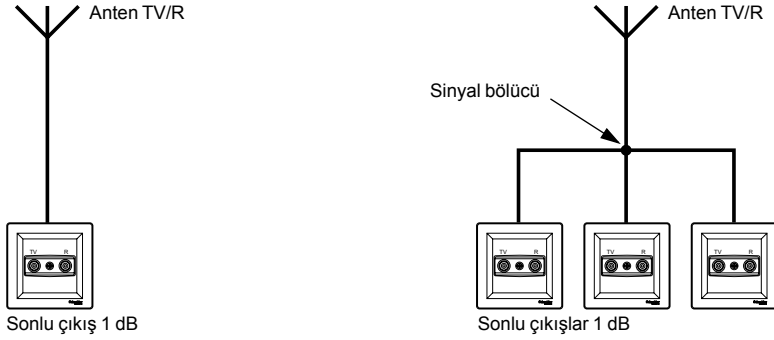

Lineer kurulum ekleri geçişli 4 dB, 8 dB ve hat sonu 1 dB (her zaman sonda)

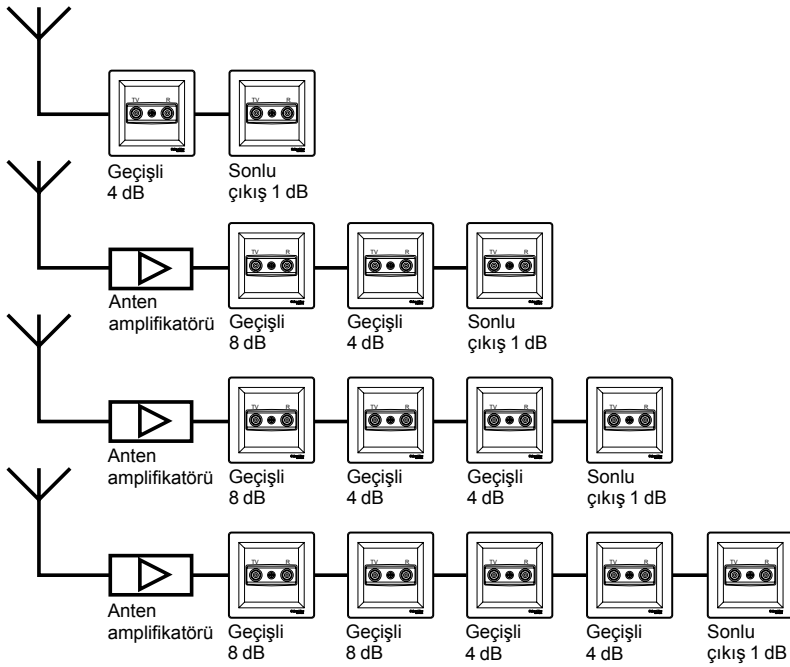

Asfora

Teknik bilgiler

Sıva üstü kasalar

Tekli montaj

(EPH61001xx)

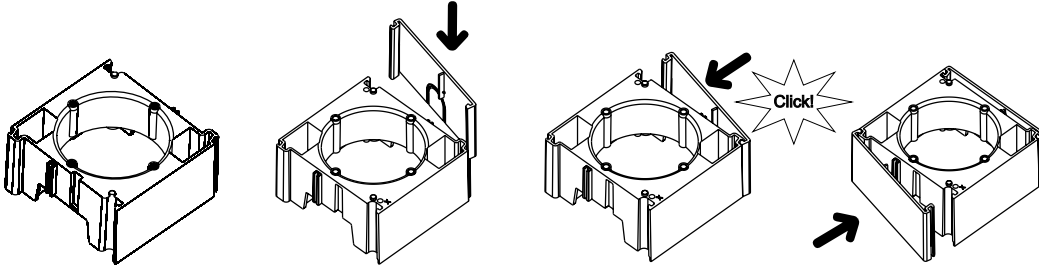

Çoklu montaj

(EPH61001xx + EPH61002xx)

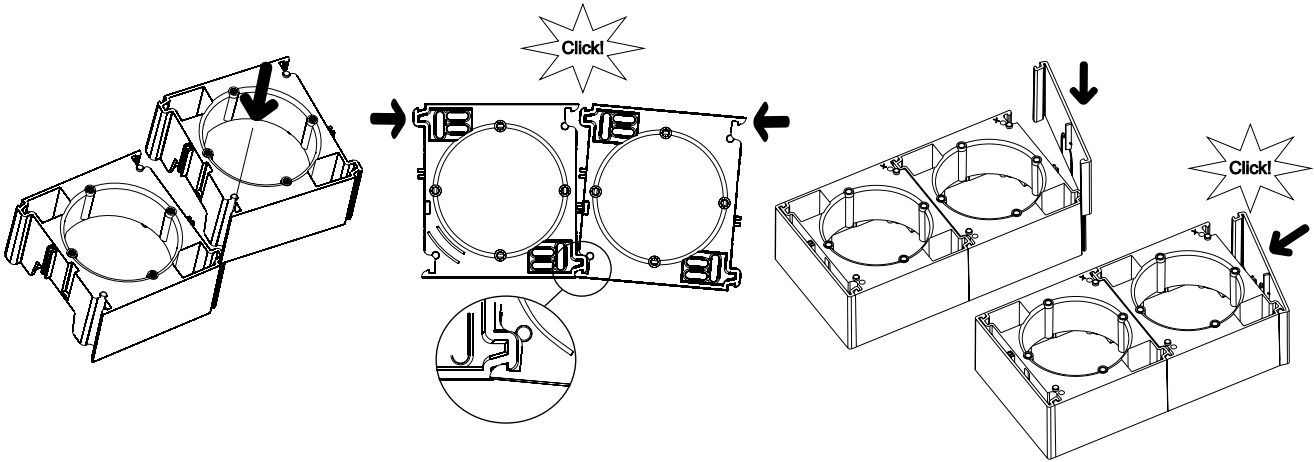

TV/R, TV/SAT, TV/R/SAT çıkışlarıyla montaj

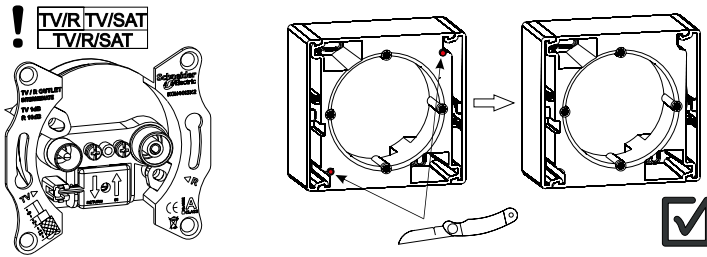

Teknik bilgiler

Boyutlar

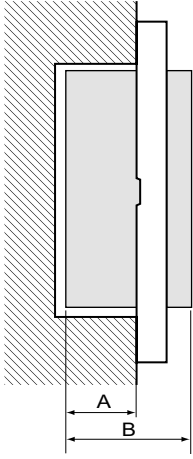

A: Gömme derinliği
B: Derinlik

Ref.	A (mm)	B (mm)	Ref.	A (mm)	B (mm)	Ref.	A (mm)	B (mm)	Ref.	A (mm)	B (mm)
EPH01001xx	28	43	EPH13001xx	28	43	PH29005xx	32	42	EPH41001xx	29	38
EPH01002xx	28	43	EPH13003xx	28	43	EPH30001xx	32	42	EPH42001xx	29	38
EPH01003xx	28	43	EPH13005xx	28	43	EPH31001xx	32	47	EPH43001xx	27	36
EPH02001xx	28	43	EPH14001xx	28	43	EPH31003xx	32	42	EPH44001xx	27	36
EPH02003xx	28	43	EPH14003xx	28	43	EPH32001xx	28	38	EPH47001xx	27	36
EPH03001xx	28	43	EPH14303xx	28	43	EPH32002xx	28	38	EPH48001xx	27	36
EPH03003xx	28	43	EPH15001xx	28	43	EPH32003xx	28	38	EPH49001xx	27	36
EPH04001xx	28	43	EPH15003xx	28	43	EPH33001xx	28	38	EPH50001xx	39	48
EPH04003xx	28	43	EPH16001xx	28	43	EPH33002xx	28	38	EPH56001xx	26	35
EPH04004xx	28	43	EPH16003xx	28	43	EPH33003xx	28	38	EPH57001xx	26	43
EPH05001xx	28	43	EPH17001xx	28	43	EPH34001xx	29	42	EPH62001xx	29	52
EPH05003xx	28	43	EPH17003xx	28	43	EPH34002xx	29	42	EPH63001xx	29	52
EPH06001xx	28	43	EPH18001xx	28	43	EPH34003xx	29	42	EPH64001xx	29	49
EPH06003xx	28	43	EPH19003xx	28	43	EPH34004xx	29	42	EPH65001xx	29	49
EPH07001xx	28	43	EPH28001xx	32	42	EPH35001xx	29	42	EPH66001xx	29	49
EPH08001xx	28	43	EPH28002xx	32	42	EPH35002xx	29	42	EPH97001xx	23	46
EPH08003xx	28	43	EPH28003xx	32	48	EPH35003xx	29	42	EPH97002xx	23	46
EPH09001xx	28	43	EPH28004xx	32	42	EPH36001xx	29	42	EPH98001xx	23	46
EPH11001xx	28	43	EPH29001xx	32	42	EPH37001xx	29	42	EPH98002xx	23	46
EPH11003xx	28	43	EPH29002xx	32	42	EPH37002xx	29	42	EPH99001xx	23	46

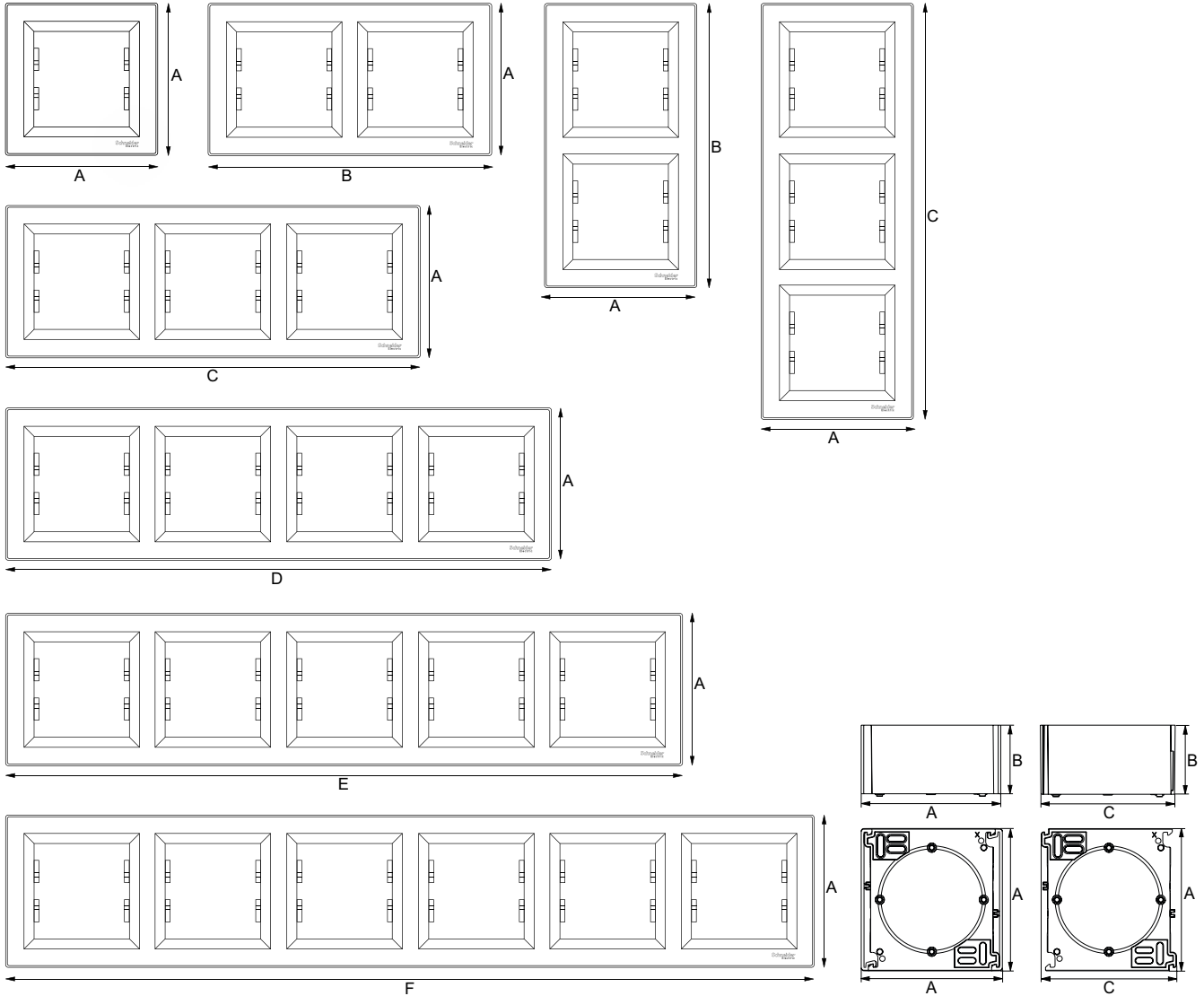

Yatay ve dikey çerçeveler (mm)

Tekli	İkili	Üçlü	Dörtlü	Beşli	Altılı
A	B	C	D	E	F
83	154	225	296	367	439

Sıva üstü kasalar (mm)

Tekli	Uzatma			
A	B	A	B	C
82	40	82	40	78

Teknik bilgiler

Boyutlar

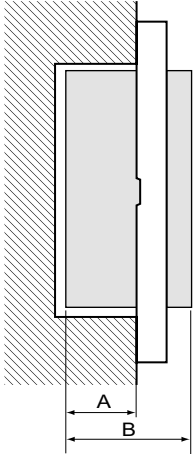

A: Gömme derinliği
B: Derinlik

Ref.	A (mm)	B (mm)	Ref.	A (mm)	B (mm)	Ref.	A (mm)	B (mm)	Ref.	A (mm)	B (mm)
EPH01001xx	28	43	EPH13001xx	28	43	EPH29005xx	32	42	EPH41001xx	29	38
EPH01002xx	28	43	EPH13003xx	28	43	EPH30001xx	32	42	EPH42001xx	29	38
EPH01003xx	28	43	EPH13005xx	28	43	EPH31001xx	32	47	EPH43001xx	27	36
EPH02001xx	28	43	EPH14001xx	28	43	EPH31003xx	32	42	EPH44001xx	27	36
EPH02003xx	28	43	EPH14003xx	28	43	EPH32001xx	28	38	EPH47001xx	27	36
EPH03001xx	28	43	EPH14303xx	28	43	EPH32002xx	28	38	EPH48001xx	27	36
EPH03003xx	28	43	EPH15001xx	28	43	EPH32003xx	28	38	EPH49001xx	27	36
EPH04001xx	28	43	EPH15003xx	28	43	EPH33001xx	28	38	EPH50001xx	39	48
EPH04003xx	28	43	EPH16001xx	28	43	EPH33002xx	28	38	EPH56001xx	26	35
EPH04004xx	28	43	EPH16003xx	28	43	EPH33003xx	28	38	EPH57001xx	26	43
EPH05001xx	28	43	EPH17001xx	28	43	EPH34001xx	29	42	EPH62001xx	29	52
EPH05003xx	28	43	EPH17003xx	28	43	EPH34002xx	29	42	EPH63001xx	29	52
EPH06001xx	28	43	EPH18001xx	28	43	EPH34003xx	29	42	EPH64001xx	29	49
EPH06003xx	28	43	EPH19003xx	28	43	EPH34004xx	29	42	EPH65001xx	29	49
EPH07001xx	28	43	EPH28001xx	32	42	EPH35001xx	29	42	EPH66001xx	29	49
EPH08001xx	28	43	EPH28002xx	32	42	EPH35002xx	29	42	EPH97001xx	23	46
EPH08003xx	28	43	EPH28003xx	32	48	EPH35003xx	29	42	EPH97002xx	23	46
EPH09001xx	28	43	EPH28004xx	32	42	EPH36001xx	29	42	EPH98001xx	23	46
EPH11001xx	28	43	EPH29001xx	32	42	EPH37001xx	29	42	EPH98002xx	23	46
EPH11003xx	28	43	EPH29002xx	32	42	EPH37002xx	29	42	EPH99001xx	23	46

Asfora EM yatay ve dikey çerçeveler (mm)

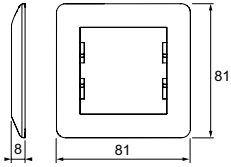

EPH58051xx

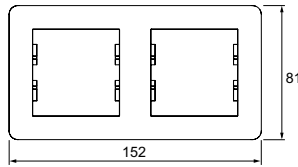

EPH58052xx

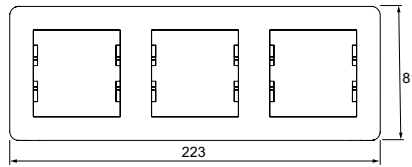

EPH58053xx

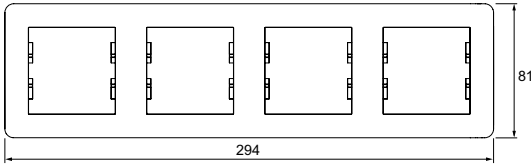

EPH58054xx

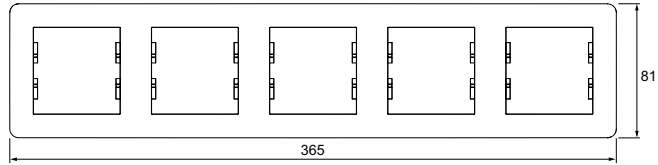

EPH58055xx

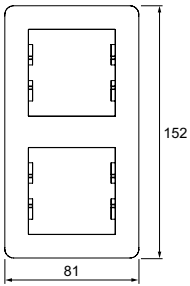

EPH58152xx

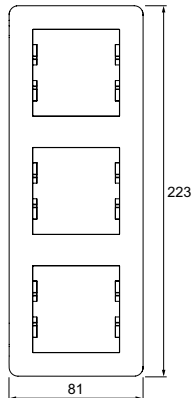

EPH58153xx

Note:

Asfora EM çerçeveler, aşağıdaki Asfora referans kodlu mekanizmalara oturmamaktadır:

- Topraklı priz IP44: EPH31001xx, EPH31003xx, EPH31701xx
- UPS priz IP44: EPH28003xx, EPH28006xx
- PL standardı ikili priz: EPH98102xx
- Energy saver: EPH62001xx, EPH62701xx
- Sıva-üstü montaj kasaları: EPH61001xx, EPH61002xx

Ref.	Sayfa	Ref.	Sayfa	Ref.	Sayfa	Ref.	Sayfa	Ref.	Sayfa
EPH0100121	10	EPH0400462	10	EPH1100121	12	EPH1500323	11	EPH2700261	18
EPH0100123	10	EPH0400469	10	EPH1100123	12	EPH1500361	11	EPH2700262	18
EPH0100161	10	EPH0400471	10	EPH1100161	12	EPH1500362	11	EPH2700269	18
EPH0100162	10	EPH0470121	10	EPH1100162	12	EPH1500369	11	EPH2700271	18
EPH0100169	10	EPH0470123	10	EPH1100169	12	EPH1500371	11	EPH2700321	18
EPH0100171	10	EPH0500121	10	EPH1100171	12	EPH1570121	11	EPH2700323	18
EPH0100221	10	EPH0500123	10	EPH1100321	12	EPH1570123	11	EPH2700361	18
EPH0100223	10	EPH0500161	10	EPH1100323	12	EPH1600121	13	EPH2700362	18
EPH0100261	10	EPH0500162	10	EPH1100361	12	EPH1600123	13	EPH2700369	18
EPH0100262	10	EPH0500169	10	EPH1100362	12	EPH1600161	13	EPH2700371	18
EPH0100269	10	EPH0500171	10	EPH1100369	12	EPH1600162	13	EPH2800121	14
EPH0100271	10	EPH0500321	10	EPH1100371	12	EPH1600169	13	EPH2800123	14
EPH0100321	10	EPH0500323	10	EPH1170121	12	EPH1600171	13	EPH2800161	14
EPH0100323	10	EPH0500361	10	EPH1170123	12	EPH1600321	13	EPH2800162	14
EPH0100361	10	EPH0500362	10	EPH1300121	13	EPH1600323	13	EPH2800169	14
EPH0100362	10	EPH0500369	10	EPH1300123	13	EPH1600361	13	EPH2800171	14
EPH0100369	10	EPH0500371	10	EPH1300161	13	EPH1600362	13	EPH2800221	14
EPH0100371	10	EPH0570121	10	EPH1300162	13	EPH1600369	13	EPH2800223	14
EPH0170121	10	EPH0570123	10	EPH1300169	13	EPH1600371	13	EPH2800261	14
EPH0170123	10	EPH0600121	10	EPH1300171	13	EPH1601521	13	EPH2800262	14
EPH0200121	10	EPH0600123	10	EPH1300321	13	EPH1601523	13	EPH2800269	14
EPH0200123	10	EPH0600161	10	EPH1300323	13	EPH1670121	13	EPH2800271	14
EPH0200161	10	EPH0600162	10	EPH1300361	13	EPH1670123	13	EPH2800321	14
EPH0200162	10	EPH0600169	10	EPH1300362	13	EPH1700121	13	EPH2800323	14
EPH0200169	10	EPH0600171	10	EPH1300369	13	EPH1700123	13	EPH2800361	14
EPH0200171	10	EPH0600321	10	EPH1300371	13	EPH1700321	13	EPH2800362	14
EPH0200321	10	EPH0600323	10	EPH1300521	11	EPH1700323	13	EPH2800369	14
EPH0200323	10	EPH0600361	10	EPH1300523	11	EPH1700361	13	EPH2800371	14
EPH0200361	10	EPH0600362	10	EPH1300561	11	EPH1700362	13	EPH2800421	14
EPH0200362	10	EPH0600369	10	EPH1300562	11	EPH1700369	13	EPH2800423	14
EPH0200369	10	EPH0600371	10	EPH1300569	11	EPH1700371	13	EPH2800621	14
EPH0200371	10	EPH0670121	10	EPH1300571	11	EPH1770121	13	EPH2800623	14
EPH0270121	10	EPH0670123	10	EPH1370121	13	EPH1770123	13	EPH2800661	14
EPH0270123	10	EPH0700121	12	EPH1370123	13	EPH1800121	13	EPH2800662	14
EPH0300121	10	EPH0700123	12	EPH1370521	11	EPH1800123	13	EPH2800669	14
EPH0300123	10	EPH0700161	12	EPH1370523	11	EPH1800161	13	EPH2800671	14
EPH0300161	10	EPH0700162	12	EPH1400121	11	EPH1800162	13	EPH2870121	14
EPH0300162	10	EPH0700169	12	EPH1400123	11	EPH1800169	13	EPH2870123	14
EPH0300169	10	EPH0700171	12	EPH1400161	11	EPH1800171	13	EPH2870442	14
EPH0300171	10	EPH0770121	12	EPH1400162	11	EPH1870121	13	EPH2900121	15
EPH0300321	10	EPH0770123	12	EPH1400169	11	EPH1870123	13	EPH2900123	15
EPH0300323	10	EPH0800121	12	EPH1400171	11	EPH1900121	13	EPH2900161	15
EPH0300361	10	EPH0800123	12	EPH1400321	11	EPH1900123	13	EPH2900162	15
EPH0300362	10	EPH0800161	12	EPH1400323	11	EPH1900161	13	EPH2900169	15
EPH0300369	10	EPH0800162	12	EPH1400361	11	EPH1900162	13	EPH2900171	15
EPH0300371	10	EPH0800169	12	EPH1400362	11	EPH1900169	13	EPH2900221	15
EPH0370121	10	EPH0800171	12	EPH1400369	11	EPH1900171	13	EPH2900223	15
EPH0370123	10	EPH0800321	12	EPH1400371	11	EPH1900321	13	EPH2900261	15
EPH0400121	10	EPH0800323	12	EPH1430321	11	EPH1900323	13	EPH2900262	15
EPH0400123	10	EPH0800361	12	EPH1430323	11	EPH1900361	13	EPH2900269	15
EPH0400161	10	EPH0800362	12	EPH1430361	11	EPH1900362	13	EPH2900271	15
EPH0400162	10	EPH0800369	12	EPH1430362	11	EPH1900369	13	EPH2900521	15
EPH0400169	10	EPH0800371	12	EPH1430369	11	EPH1900371	13	EPH2900523	15
EPH0400171	10	EPH0870121	12	EPH1430371	11	EPH2100121	10	EPH2970121	15
EPH0400321	10	EPH0870123	12	EPH1470121	11	EPH2100123	10	EPH2970123	15
EPH0400323	10	EPH0900121	12	EPH1470123	11	EPH2100161	10	EPH2970221	15
EPH0400361	10	EPH0900123	12	EPH1500121	11	EPH2100162	10	EPH2970223	15
EPH0400362	10	EPH0900161	12	EPH1500123	11	EPH2100169	10	EPH2970542	15
EPH0400369	10	EPH0900162	12	EPH1500161	11	EPH2100171	10	EPH3000121	14
EPH0400371	10	EPH0900169	12	EPH1500162	11	EPH2170121	10		
EPH0400421	10	EPH0900171	12	EPH1500169	11	EPH2170123	10		
EPH0400423	10	EPH0970121	12	EPH1500171	11	EPH2700221	18		
EPH0400461	10	EPH0970123	12	EPH1500321	11	EPH2700223	18		

Ref.	Sayfa	Ref.	Sayfa	Ref.	Sayfa	Ref.	Sayfa	Ref.	Sayfa
EPH3000123	14	EPH3400161	16	EPH3700271	16	EPH5200121	17	EPH5800662	19
EPH3000161	14	EPH3400162	16	EPH3770121	16	EPH5200123	17	EPH5800669	19
EPH3000162	14	EPH3400169	16	EPH3770123	16	EPH5200161	17	EPH5800671	19
EPH3000169	14	EPH3400171	16	EPH4100121	17	EPH5200162	17	EPH5810221	19
EPH3000171	14	EPH3400221	16	EPH4100123	17	EPH5200169	17	EPH5810223	19
EPH3100121	15	EPH3400223	16	EPH4100161	17	EPH5200171	17	EPH5810261	19
EPH3100123	15	EPH3400261	16	EPH4100162	17	EPH5270121	17	EPH5810262	19
EPH3100161	15	EPH3400262	16	EPH4100169	17	EPH5270123	17	EPH5810269	19
EPH3100162	15	EPH3400269	16	EPH4100171	17	EPH5500121	15	EPH5810271	19
EPH3100169	15	EPH3400271	16	EPH4170121	17	EPH5500123	15	EPH5810321	19
EPH3100171	15	EPH3400321	16	EPH4170123	17	EPH5500161	15	EPH5810323	19
EPH3100321	15	EPH3400323	16	EPH4200121	17	EPH5500162	15	EPH5810361	19
EPH3100323	15	EPH3400361	16	EPH4200123	17	EPH5500169	15	EPH5810362	19
EPH3100361	15	EPH3400362	16	EPH4200161	17	EPH5500171	15	EPH5810369	19
EPH3100362	15	EPH3400369	16	EPH4200162	17	EPH5600121	19	EPH5810371	19
EPH3100369	15	EPH3400371	16	EPH4200169	17	EPH5600123	19	EPH6100121	19
EPH3100371	15	EPH3400421	16	EPH4200171	17	EPH5600161	19	EPH6100123	19
EPH3170121	15	EPH3400423	16	EPH4270121	17	EPH5600162	19	EPH6100161	19
EPH3170123	15	EPH3400461	16	EPH4270123	17	EPH5600169	19	EPH6100162	19
EPH3200121	16	EPH3400462	16	EPH4300121	17	EPH5600171	19	EPH6100169	19
EPH3200123	16	EPH3400469	16	EPH4300123	17	EPH5670121	19	EPH6100171	19
EPH3200161	16	EPH3400471	16	EPH4300161	17	EPH5670123	19	EPH6100221	19
EPH3200162	16	EPH3470121	16	EPH4300162	17	EPH5700121	17	EPH6100223	19
EPH3200169	16	EPH3470123	16	EPH4300169	17	EPH5700123	17	EPH6100261	19
EPH3200171	16	EPH3470321	16	EPH4300171	17	EPH5700161	17	EPH6100262	19
EPH3200221	16	EPH3470323	16	EPH4370121	17	EPH5700162	17	EPH6100269	19
EPH3200223	16	EPH3500121	16	EPH4370123	17	EPH5700169	17	EPH6100271	19
EPH3200261	16	EPH3500123	16	EPH4400121	17	EPH5700171	17	EPH6200121	11
EPH3200262	16	EPH3500161	16	EPH4400123	17	EPH5770121	17	EPH6200123	11
EPH3200269	16	EPH3500162	16	EPH4400161	17	EPH5770123	17	EPH6200161	11
EPH3200271	16	EPH3500169	16	EPH4400162	17	EPH5800121	19	EPH6200162	11
EPH3200321	16	EPH3500171	16	EPH4400169	17	EPH5800123	19	EPH6200169	11
EPH3200323	16	EPH3500221	16	EPH4400171	17	EPH5800161	19	EPH6200171	11
EPH3200361	16	EPH3500223	16	EPH4470121	17	EPH5800162	19	EPH6270121	11
EPH3200362	16	EPH3500261	16	EPH4470123	17	EPH5800169	19	EPH6270123	11
EPH3200369	16	EPH3500262	16	EPH4700121	17	EPH5800171	19	EPH6400121	18
EPH3200371	16	EPH3500269	16	EPH4700123	17	EPH5800221	19	EPH6400123	18
EPH3270121	16	EPH3500271	16	EPH4700161	17	EPH5800223	19	EPH6400161	18
EPH3270123	16	EPH3500321	16	EPH4700162	17	EPH5800261	19	EPH6400162	18
EPH3270321	16	EPH3500323	16	EPH4700169	17	EPH5800262	19	EPH6400169	18
EPH3270323	16	EPH3500361	16	EPH4700171	17	EPH5800269	19	EPH6400171	18
EPH3300121	16	EPH3500362	16	EPH4770121	17	EPH5800271	19	EPH6470121	18
EPH3300123	16	EPH3500369	16	EPH4770123	17	EPH5800321	19	EPH6470123	18
EPH3300161	16	EPH3500371	16	EPH4800121	17	EPH5800323	19	EPH6500121	18
EPH3300162	16	EPH3600121	16	EPH4800123	17	EPH5800361	19	EPH6500123	18
EPH3300169	16	EPH3600123	16	EPH4800161	17	EPH5800362	19	EPH6500161	18
EPH3300171	16	EPH3600161	16	EPH4800162	17	EPH5800369	19	EPH6500162	18
EPH3300221	16	EPH3600162	16	EPH4800169	17	EPH5800371	19	EPH6500169	18
EPH3300223	16	EPH3600169	16	EPH4800171	17	EPH5800421	19	EPH6500171	18
EPH3300261	16	EPH3600171	16	EPH4870121	17	EPH5800423	19	EPH6570121	18
EPH3300262	16	EPH3670121	16	EPH4870123	17	EPH5800461	19	EPH6570123	18
EPH3300269	16	EPH3670123	16	EPH4900121	17	EPH5800462	19	EPH6600121	18
EPH3300271	16	EPH3700121	16	EPH4900123	17	EPH5800469	19	EPH6600123	18
EPH3300321	16	EPH3700123	16	EPH4900161	17	EPH5800471	19	EPH6600161	18
EPH3300323	16	EPH3700161	16	EPH4900162	17	EPH5800521	19	EPH6600162	18
EPH3300361	16	EPH3700162	16	EPH4900169	17	EPH5800523	19	EPH6600169	18
EPH3300362	16	EPH3700169	16	EPH4900171	17	EPH5800561	19	EPH6600171	18
EPH3300369	16	EPH3700171	16	EPH5000121	17	EPH5800562	19	EPH6670121	18
EPH3300371	16	EPH3700221	16	EPH5000123	17	EPH5800569	19	EPH6670123	18
EPH3300721	16	EPH3700223	16	EPH5000161	17	EPH5800571	19	EPH9700121	14
EPH3300723	16	EPH3700261	16	EPH5000162	17	EPH5800621	19	EPH9700123	14
EPH3400121	16	EPH3700262	16	EPH5000169	17	EPH5800623	19	EPH9700161	14
EPH3400123	16	EPH3700269	16	EPH5000171	17	EPH5800661	19	EPH9700162	14

Ref.	Sayfa	Ref.	Sayfa
EPH9700169	14	EPH5805121	20
EPH9700171	14	EPH5805123	20
EPH9700221	14	EPH5805161	20
EPH9700223	14	EPH5805162	20
EPH9700261	14	EPH5805169	20
EPH9700262	14	EPH5805171	20
EPH9700269	14	EPH5805221	20
EPH9700271	14	EPH5805223	20
EPH9800121	14	EPH5805261	20
EPH9800123	14	EPH5805262	20
EPH9800161	14	EPH5805269	20
EPH9800162	14	EPH5805271	20
EPH9800169	14	EPH5805321	20
EPH9800171	14	EPH5805323	20
EPH9800221	14	EPH5805361	20
EPH9800223	14	EPH5805362	20
EPH9800261	14	EPH5805369	20
EPH9800262	14	EPH5805371	20
EPH9800269	14	EPH5805421	20
EPH9800271	14	EPH5805423	20
EPH9810221	14	EPH5805461	20
EPH9810223	14	EPH5805462	20
EPH9810261	14	EPH5805469	20
EPH9810262	14	EPH5805471	20
EPH9810269	14	EPH5805521	20
EPH9810271	14	EPH5805523	20
EPH9900121	15	EPH5805561	20
EPH9900123	15	EPH5805562	20
EPH9900161	15	EPH5805569	20
EPH9900162	15	EPH5805571	20
EPH9900169	15	EPH5815221	20
EPH9900171	15	EPH5815223	20
		EPH5815261	20
		EPH5815262	20
		EPH5815269	20
		EPH5815271	20
		EPH5815321	20
		EPH5815323	20
		EPH5815361	20
		EPH5815362	20
		EPH5815369	20
		EPH5815371	20

Green Premium™

Sürdürülebilir değer sağlayan sektör lideri ürün portföyü



Ürün satışlarımızın %75'inde malzeme içeriği, idari bilgiler ve ürünlerin çevre üzerindeki etkisi anlamında şeffaflık sağlanmaktadır:

- RoHS uyumluluğu
- REACH malzeme bilgileri
- Sektör lideri PEP sayısı*
- Talimat sirkülerleri

Green Premium programı müşterilerimize katma değerli sürdürülebilir performans sağlama taahhüdümüzü yansıtmaktadır. Yaygın kabul gören çevresel taahhütler ile iyileştirilmiş ve Ürün, Hizmet ve Çözümler dahil tüm çözümleri kapsayacak şekilde genişletilmiştir.

CO₂ ve P&L etkisi için... Kaynak Planlama

Green Premium varlık kullanım döngüsünün tamamında daha yüksek kaynak verimliliği sağlar. Enerji ve doğal kaynakların daha verimli kullanımı ve minimum CO₂ emisyonu da buna dahildir.

Sahip olma maliyeti optimizasyonu için... Döngüsel Performans

Müşterilerimize varlıklarının toplam sahip olma maliyetini optimize etmelerinde yardımcı oluyoruz. Bunun için IoT özellikli çözümlerin yanı sıra iyileştirme, onarım, yenileme ve tekrar üretim hizmetleri sunuyoruz.

Rahat etmeniz için... Sağlık Performansı

Green Premium ürünler RoHS ve REACH ile uyumludur. Ürünlerimizdeki belirli madde ve malzemelerin kademeli olarak değiştirilmesi yoluyla idari gereksinimlerin ötesine geçiyoruz.

Daha fazla satış için... Farklılaştırma

Green Premium başka şirket marka ve hizmetleri aracılığıyla güçlü katma değerler sunar. Yeşil bina sertifikasyonları gibi sürdürülebilirlik hedeflerine ulaşmalarında müşterilerimize yardımcı olmak amacıyla başka kuruluşlarla işbirlikleri yapıyoruz.

*PEP: Ürün Çevre Profili (yani Çevre Dostu Ürün Beyanı)



Yeşil derken ne
kastettiğimizi keşfedin

Ürünlerinizi kontrol edin!

Life Is On

Schneider
Electric

Life Is On | Schneider
Electric

Schneider Elektrik Sanayi ve Ticaret A.Ş.

Küçükbakkalköy Mah. Defne Sokak
No: 3 34750 Ataşehir / İstanbul
Tel: +90(216) 655 88 88
Faks: +90(216) 655 87 87

se.com/tr

07-2020
2020

© 2019 - Schneider Electric. Her Hakkı Saklıdır.
Tüm ticari markalar, Schneider Electric Industries SAS veya bağlı şirketlerine aittir.
Belge referansı: LSB02658EN