

Modicon TMC2

Cartridges

Hardware Guide

12/2018

EIO0000003337.00

www.schneider-electric.com



The information provided in this documentation contains general descriptions and/or technical characteristics of the performance of the products contained herein. This documentation is not intended as a substitute for and is not to be used for determining suitability or reliability of these products for specific user applications. It is the duty of any such user or integrator to perform the appropriate and complete risk analysis, evaluation and testing of the products with respect to the relevant specific application or use thereof. Neither Schneider Electric nor any of its affiliates or subsidiaries shall be responsible or liable for misuse of the information contained herein. If you have any suggestions for improvements or amendments or have found errors in this publication, please notify us.

You agree not to reproduce, other than for your own personal, noncommercial use, all or part of this document on any medium whatsoever without permission of Schneider Electric, given in writing. You also agree not to establish any hypertext links to this document or its content. Schneider Electric does not grant any right or license for the personal and noncommercial use of the document or its content, except for a non-exclusive license to consult it on an "as is" basis, at your own risk. All other rights are reserved.

All pertinent state, regional, and local safety regulations must be observed when installing and using this product. For reasons of safety and to help ensure compliance with documented system data, only the manufacturer should perform repairs to components.

When devices are used for applications with technical safety requirements, the relevant instructions must be followed.

Failure to use Schneider Electric software or approved software with our hardware products may result in injury, harm, or improper operating results.

Failure to observe this information can result in injury or equipment damage.

© 2018 Schneider Electric. All rights reserved.

Table of Contents



	Safety Information	5
	About the Book	7
Part I	TMC2 General Overview	13
Chapter 1	TMC2 Description	15
	General Description	15
Chapter 2	TMC2 Installation	17
2.1	TMC2 General Rules for Implementing	18
	Environmental Characteristics	19
	Certifications and Standards	20
2.2	TMC2 Installation	21
	Installation and Maintenance Requirements	22
	TMC2 Installation	24
2.3	TMC2 Electrical Requirements	30
	Wiring Best Practices	31
	Grounding the M221 System	34
Part II	TMC2 Standard Cartridges	37
Chapter 3	TMC2AI2 Analog Voltage, Current Inputs	39
	TMC2AI2 Presentation	40
	TMC2AI2 Characteristics	41
	TMC2AI2 Wiring Diagram	43
Chapter 4	TMC2TI2 Analog Temperature Inputs	45
	TMC2TI2 Presentation	46
	TMC2TI2 Characteristics	47
	TMC2TI2 Wiring Diagram	50
Chapter 5	TMC2AQ2V Analog Voltage Outputs	51
	TMC2AQ2V Presentation	52
	TMC2AQ2V Characteristics	53
	TMC2AQ2V Wiring Diagram	55
Chapter 6	TMC2AQ2C Analog Current Outputs	57
	TMC2AQ2C Presentation	58
	TMC2AQ2C Characteristics	59
	TMC2AQ2C Wiring Diagram	61

Chapter 7	TMC2SL1 Serial Line	63
	TMC2SL1 Presentation	64
	TMC2SL1 Characteristics	65
	TMC2SL1 Wiring Diagram	67
Part III	TMC2 Application Cartridges	69
Chapter 8	TMC2HOIS01 Hoisting	71
	TMC2HOIS01 Presentation	72
	TMC2HOIS01 Characteristics	73
	TMC2HOIS01 Wiring Diagram	75
Chapter 9	TMC2PACK01 Packaging	77
	TMC2PACK01 Presentation	78
	TMC2PACK01 Characteristics	79
	TMC2PACK01 Wiring Diagram	81
Chapter 10	TMC2CONV01 Conveying	83
	TMC2CONV01 Presentation	84
	TMC2CONV01 Characteristics	85
	TMC2CONV01 Wiring Diagram	87
Glossary	89
Index	91

Safety Information



Important Information

NOTICE

Read these instructions carefully, and look at the equipment to become familiar with the device before trying to install, operate, service, or maintain it. The following special messages may appear throughout this documentation or on the equipment to warn of potential hazards or to call attention to information that clarifies or simplifies a procedure.



The addition of this symbol to a “Danger” or “Warning” safety label indicates that an electrical hazard exists which will result in personal injury if the instructions are not followed.



This is the safety alert symbol. It is used to alert you to potential personal injury hazards. Obey all safety messages that follow this symbol to avoid possible injury or death.

DANGER

DANGER indicates a hazardous situation which, if not avoided, **will result in** death or serious injury.

WARNING

WARNING indicates a hazardous situation which, if not avoided, **could result in** death or serious injury.

CAUTION

CAUTION indicates a hazardous situation which, if not avoided, **could result in** minor or moderate injury.

NOTICE

NOTICE is used to address practices not related to physical injury.

PLEASE NOTE

Electrical equipment should be installed, operated, serviced, and maintained only by qualified personnel. No responsibility is assumed by Schneider Electric for any consequences arising out of the use of this material.

A qualified person is one who has skills and knowledge related to the construction and operation of electrical equipment and its installation, and has received safety training to recognize and avoid the hazards involved.

About the Book



At a Glance

Document Scope

This guide describes the hardware implementation of TMC2. It provides the parts description, characteristics, wiring diagrams, and installation details for TMC2.

Validity Note

The information in this manual is applicable **only** for TMC2 products.

This document has been updated for the release of EcoStruxure™ Machine Expert - Basic V1.0.

For product compliance and environmental information (RoHS, REACH, PEP, EOLI, etc.), go to www.schneider-electric.com/green-premium.

The technical characteristics of the devices described in the present document also appear online. To access the information online:

Step	Action
1	Go to the Schneider Electric home page www.schneider-electric.com .
2	In the Search box type the reference of a product or the name of a product range. <ul style="list-style-type: none">● Do not include blank spaces in the reference or product range.● To get information on grouping similar modules, use asterisks (*).
3	If you entered a reference, go to the Product Datasheets search results and click on the reference that interests you. If you entered the name of a product range, go to the Product Ranges search results and click on the product range that interests you.
4	If more than one reference appears in the Products search results, click on the reference that interests you.
5	Depending on the size of your screen, you may need to scroll down to see the data sheet.
6	To save or print a data sheet as a .pdf file, click Download XXX product datasheet .

The characteristics that are presented in the present document should be the same as those characteristics that appear online. In line with our policy of constant improvement, we may revise content over time to improve clarity and accuracy. If you see a difference between the document and online information, use the online information as your reference.

Related Documents

Title of Documentation	Reference Number
Modicon TMC2 Cartridges - Programming Guide	EIO0000003329 (ENG) EIO0000003330 (FRA) EIO0000003331 (GER) EIO0000003332 (SPA) EIO0000003333 (ITA) EIO0000003334 (CHS) EIO0000003335 (POR) EIO0000003336 (TUR)
Modicon M221 Logic Controller - Hardware Guide	EIO0000003313 (ENG) EIO0000003314 (FRA) EIO0000003315 (GER) EIO0000003316 (SPA) EIO0000003317 (ITA) EIO0000003318 (CHS) EIO0000003319 (POR) EIO0000003320 (TUR)

You can download these technical publications and other technical information from our website at <https://www.schneider-electric.com/en/download>

Product Related Information

 **DANGER**

HAZARD OF ELECTRIC SHOCK, EXPLOSION OR ARC FLASH

- Disconnect all power from all equipment including connected devices prior to removing any covers or doors, or installing or removing any accessories, hardware, cables, or wires except under the specific conditions specified in the appropriate hardware guide for this equipment.
- Always use a properly rated voltage sensing device to confirm the power is off where and when indicated.
- Replace and secure all covers, accessories, hardware, cables, and wires and confirm that a proper ground connection exists before applying power to the unit.
- Use only the specified voltage when operating this equipment and any associated products.

Failure to follow these instructions will result in death or serious injury.

DANGER

POTENTIAL FOR EXPLOSION

- Only use this equipment in non-hazardous locations, or in locations that comply with Class I, Division 2, Groups A, B, C and D.
- Do not substitute components which would impair compliance to Class I, Division 2.
- Do not connect or disconnect equipment unless power has been removed or the location is known to be non-hazardous.
- Do not use the USB port(s), if so equipped, unless the location is known to be non-hazardous.

Failure to follow these instructions will result in death or serious injury.

WARNING

LOSS OF CONTROL

- The designer of any control scheme must consider the potential failure modes of control paths and, for certain critical control functions, provide a means to achieve a safe state during and after a path failure. Examples of critical control functions are emergency stop and overtravel stop, power outage and restart.
- Separate or redundant control paths must be provided for critical control functions.
- System control paths may include communication links. Consideration must be given to the implications of unanticipated transmission delays or failures of the link.
- Observe all accident prevention regulations and local safety guidelines.¹
- Each implementation of this equipment must be individually and thoroughly tested for proper operation before being placed into service.

Failure to follow these instructions can result in death, serious injury, or equipment damage.

¹ For additional information, refer to NEMA ICS 1.1 (latest edition), "Safety Guidelines for the Application, Installation, and Maintenance of Solid State Control" and to NEMA ICS 7.1 (latest edition), "Safety Standards for Construction and Guide for Selection, Installation and Operation of Adjustable-Speed Drive Systems" or their equivalent governing your particular location.

WARNING

UNINTENDED EQUIPMENT OPERATION

- Only use software approved by Schneider Electric for use with this equipment.
- Update your application program every time you change the physical hardware configuration.

Failure to follow these instructions can result in death, serious injury, or equipment damage.

Terminology Derived from Standards

The technical terms, terminology, symbols and the corresponding descriptions in this manual, or that appear in or on the products themselves, are generally derived from the terms or definitions of international standards.

In the area of functional safety systems, drives and general automation, this may include, but is not limited to, terms such as *safety*, *safety function*, *safe state*, *fault*, *fault reset*, *malfunction*, *failure*, *error*, *error message*, *dangerous*, etc.

Among others, these standards include:

Standard	Description
EN 61131-2:2007	Programmable controllers, part 2: Equipment requirements and tests.
ISO 13849-1:2008	Safety of machinery: Safety related parts of control systems. General principles for design.
EN 61496-1:2013	Safety of machinery: Electro-sensitive protective equipment. Part 1: General requirements and tests.
ISO 12100:2010	Safety of machinery - General principles for design - Risk assessment and risk reduction
EN 60204-1:2006	Safety of machinery - Electrical equipment of machines - Part 1: General requirements
EN 1088:2008 ISO 14119:2013	Safety of machinery - Interlocking devices associated with guards - Principles for design and selection
ISO 13850:2006	Safety of machinery - Emergency stop - Principles for design
EN/IEC 62061:2005	Safety of machinery - Functional safety of safety-related electrical, electronic, and electronic programmable control systems
IEC 61508-1:2010	Functional safety of electrical/electronic/programmable electronic safety-related systems: General requirements.
IEC 61508-2:2010	Functional safety of electrical/electronic/programmable electronic safety-related systems: Requirements for electrical/electronic/programmable electronic safety-related systems.
IEC 61508-3:2010	Functional safety of electrical/electronic/programmable electronic safety-related systems: Software requirements.
IEC 61784-3:2008	Digital data communication for measurement and control: Functional safety field buses.
2006/42/EC	Machinery Directive
2014/30/EU	Electromagnetic Compatibility Directive
2014/35/EU	Low Voltage Directive

In addition, terms used in the present document may tangentially be used as they are derived from other standards such as:

Standard	Description
IEC 60034 series	Rotating electrical machines
IEC 61800 series	Adjustable speed electrical power drive systems
IEC 61158 series	Digital data communications for measurement and control – Fieldbus for use in industrial control systems

Finally, the term *zone of operation* may be used in conjunction with the description of specific hazards, and is defined as it is for a *hazard zone* or *danger zone* in the *Machinery Directive (2006/42/EC)* and *ISO 12100:2010*.

NOTE: The aforementioned standards may or may not apply to the specific products cited in the present documentation. For more information concerning the individual standards applicable to the products described herein, see the characteristics tables for those product references.

Part I

TMC2 General Overview

What Is in This Part?

This part contains the following chapters:

Chapter	Chapter Name	Page
1	TMC2 Description	15
2	TMC2 Installation	17

Chapter 1

TMC2 Description

General Description

Introduction

The cartridges are designed to be connected to the Modicon TM221C Logic Controller range.

Cartridges Features

The following table describes the TMC2 cartridges features:

Reference	Description
TMC2AI2 <i>(see page 39)</i>	TMC2 cartridge with 2 analog voltage or current inputs (0...10 V, 0...20 mA, 4...20 mA), 12 bits
TMC2TI2 <i>(see page 45)</i>	TMC2 cartridge with 2 analog temperature inputs (thermocouple, RTD), 14 bits
TMC2AQ2V <i>(see page 51)</i>	TMC2 cartridge with 2 analog voltage outputs (0...10 V), 12 bits
TMC2AQ2C <i>(see page 57)</i>	TMC2 cartridge with 2 analog current outputs (4...20 mA), 12 bits
TMC2SL1 <i>(see page 63)</i>	TMC2 cartridge with 1 serial line (RS232 or RS485)
TMC2HOIS01 <i>(see page 71)</i>	TMC2 application cartridge with 2 analog voltage or current inputs for hoisting load cells
TMC2PACK01 <i>(see page 77)</i>	TMC2 application cartridge with 2 analog voltage or current inputs for packaging
TMC2CONV01 <i>(see page 83)</i>	TMC2 application cartridge with 1 serial line for conveying

Logic Controller Compatibility

NOTE: For more information on cartridge compatibility with specific controllers, refer to your controller-specific hardware guide.

The following table describes the number of TMC2 cartridges that can be installed in a Modicon TM221C Logic Controller:

Reference	Cartridge Slots	Compatible Cartridges Combination	
		TMC2AI2 TMC2TI2 TMC2AQ2V TMC2AQ2C TMC2HOIS01 TMC2PACK01	TMC2SL1 TMC2CONV01
TM221C16R TM221CE16R TM221C16T TM221CE16T TM221C24R TM221CE24R TM221C24T TM221CE24T	1	1	0
		0	1
TM221C40R TM221CE40R TM221C40T TM221CE40T	2 ⁽¹⁾	1	0
		0	1
		1	1
		2	0
(1) Only one serial line cartridge (TMC2SL1, TMC2CONV01) may be added to a logic controller.			

NOTICE

ELECTROSTATIC DISCHARGE

- Verify that empty cartridge slots have their covers in place before applying power to the controller.
- Do not touch the contacts of the cartridge.
- Only handle the cartridge on the housing.
- Take the necessary protective measures against electrostatic discharges.

Failure to follow these instructions can result in equipment damage.

Chapter 2

TMC2 Installation

What Is in This Chapter?

This chapter contains the following sections:

Section	Topic	Page
2.1	TMC2 General Rules for Implementing	18
2.2	TMC2 Installation	21
2.3	TMC2 Electrical Requirements	30

Section 2.1

TMC2 General Rules for Implementing

What Is in This Section?

This section contains the following topics:

Topic	Page
Environmental Characteristics	19
Certifications and Standards	20

Environmental Characteristics

TMC2

TMC2 cartridge environmental characteristics are the same as the Modicon TM221C Logic Controller (*see Modicon M221 Logic Controller, Hardware Guide*).

Certifications and Standards

Introduction

The M221 Logic Controllers are designed to conform to the main national and international standards concerning electronic industrial control devices:

- IEC/EN 61131-2
- UL 508

The M221 Logic Controllers have obtained the following conformity marks:

- CE
- CSA (except for TM221C•••U)
- EAC
- RCM
- UL
- cCSAus Hazardous Location (except for TM221C•••U)

For product compliance and environmental information (RoHS, REACH, PEP, EOLI, etc.), go to www.schneider-electric.com/green-premium.

Section 2.2

TMC2 Installation

What Is in This Section?

This section contains the following topics:

Topic	Page
Installation and Maintenance Requirements	22
TMC2 Installation	24

Installation and Maintenance Requirements

Before Starting

Read and understand this chapter before beginning the installation of your system.

The use and application of the information contained herein require expertise in the design and programming of automated control systems. Only you, the user, machine builder or integrator, can be aware of all the conditions and factors present during installation and setup, operation, and maintenance of the machine or process, and can therefore determine the automation and associated equipment and the related safeties and interlocks which can be effectively and properly used. When selecting automation and control equipment, and any other related equipment or software, for a particular application, you must also consider any applicable local, regional or national standards and/or regulations.

Pay particular attention in conforming to any safety information, different electrical requirements, and normative standards that would apply to your machine or process in the use of this equipment.

Disconnecting Power

All options and modules should be assembled and installed before installing the control system on a mounting rail, onto a mounting plate or in a panel. Remove the control system from its mounting rail, mounting plate or panel before disassembling the equipment.

DANGER

HAZARD OF ELECTRIC SHOCK, EXPLOSION OR ARC FLASH

- Disconnect all power from all equipment including connected devices prior to removing any covers or doors, or installing or removing any accessories, hardware, cables, or wires except under the specific conditions specified in the appropriate hardware guide for this equipment.
- Always use a properly rated voltage sensing device to confirm the power is off where and when indicated.
- Replace and secure all covers, accessories, hardware, cables, and wires and confirm that a proper ground connection exists before applying power to the unit.
- Use only the specified voltage when operating this equipment and any associated products.

Failure to follow these instructions will result in death or serious injury.

Programming Considerations

WARNING

UNINTENDED EQUIPMENT OPERATION

- Only use software approved by Schneider Electric for use with this equipment.
- Update your application program every time you change the physical hardware configuration.

Failure to follow these instructions can result in death, serious injury, or equipment damage.

Operating Environment

In addition to the **Environmental Characteristics**, refer to **Product Related Information** in the beginning of the present document for important information regarding installation in hazardous locations for this specific equipment.

NOTE: For important safety information and the environment characteristics of the TMC2 cartridges, see the M221 Logic Controller Hardware Guide.

Installation Considerations

WARNING

UNINTENDED EQUIPMENT OPERATION

- Use appropriate safety interlocks where personnel and/or equipment hazards exist.
- Install and operate this equipment in an enclosure appropriately rated for its intended environment and secured by a keyed or tooled locking mechanism.
- Use the sensor and actuator power supplies only for supplying power to the sensors or actuators connected to the module.
- Power line and output circuits must be wired and fused in compliance with local and national regulatory requirements for the rated current and voltage of the particular equipment.
- Do not use this equipment in safety-critical machine functions unless the equipment is otherwise designated as functional safety equipment and conforming to applicable regulations and standards.
- Do not disassemble, repair, or modify this equipment.
- Do not connect any wiring to reserved, unused connections, or to connections designated as No Connection (N.C.).

Failure to follow these instructions can result in death, serious injury, or equipment damage.

NOTE: JDYX2 or JDYX8 fuse types are UL-recognized and CSA approved.

TMC2 Installation

Installation Considerations

The TMC2 cartridge is designed to operate within the same temperature range as the controllers, including the controller derating for extended temperature operation, and temperature restrictions associated with the mounting positions. Refer to the controller mounting position and clearance (see *Modicon M221 Logic Controller, Hardware Guide*) for more information.

Installation

DANGER

ELECTRIC SHOCK OR ARC FLASH

- Disconnect all power from all equipment including connected devices prior to removing any covers or doors, or installing or removing any accessories, hardware, cables, or wires.
- Always use a properly rated voltage sensing device to confirm the power is off where and when indicated.
- Use protective gloves when installing or removing the cartridges.
- Replace and secure all covers, accessories, hardware, cables, and wires and confirm that a proper ground connection exists before applying power to the unit.
- Use only the specified voltage when operating this equipment and any associated products.

Failure to follow these instructions will result in death or serious injury.

NOTICE

ELECTROSTATIC DISCHARGE

- Verify that empty cartridge slots have their covers in place before applying power to the controller.
- Do not touch the contacts of the cartridge.
- Only handle the cartridge on the housing.
- Take the necessary protective measures against electrostatic discharges.

Failure to follow these instructions can result in equipment damage.

The following table describes the different steps to install a TMC2 cartridge on the controller:

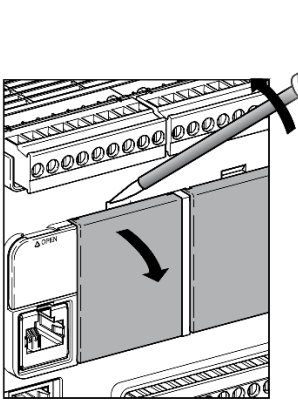
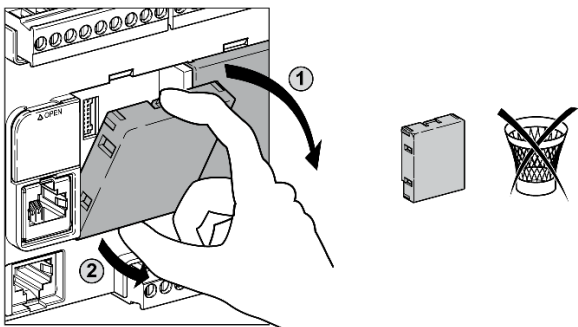
Step	Action
1	Disconnect all power from all equipment prior to removing any covers or installing a cartridge.
2	Remove the cartridge from the packaging.
3	Press the locking clip on the top of the cartridge cover with an insulated screwdriver and pull up the cover gently.
	
4	Remove by hand the cartridge slot cover from the controller. NOTE: Keep the cover to reuse it for the de-installation.
	

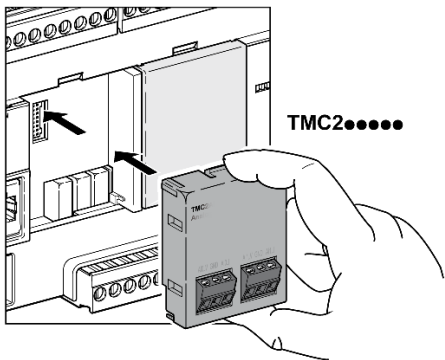
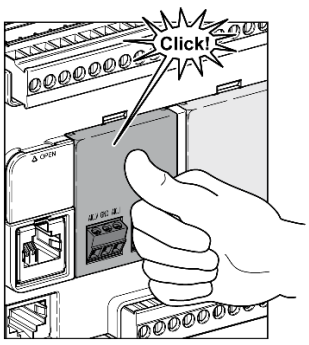
Step	Action
5	<p data-bbox="288 203 727 227">Place the cartridge in the slot on the controller.</p>  <p data-bbox="583 341 699 365">TMC2●●●●●</p>
6	<p data-bbox="288 641 699 665">Push the cartridge into the slot until it clicks.</p>  <p data-bbox="452 698 507 722">Click!</p>

De-installation

DANGER

ELECTRIC SHOCK OR ARC FLASH

- Disconnect all power from all equipment including connected devices prior to removing any covers or doors, or installing or removing any accessories, hardware, cables, or wires.
- Always use a properly rated voltage sensing device to confirm the power is off where and when indicated.
- Use protective gloves when installing or removing the cartridges.
- Replace and secure all covers, accessories, hardware, cables, and wires and confirm that a proper ground connection exists before applying power to the unit.
- Use only the specified voltage when operating this equipment and any associated products.

Failure to follow these instructions will result in death or serious injury.

NOTICE

ELECTROSTATIC DISCHARGE

- Verify that empty cartridge slots have their covers in place before applying power to the controller.
- Do not touch the contacts of the cartridge.
- Only handle the cartridge on the housing.
- Take the necessary protective measures against electrostatic discharges.

Failure to follow these instructions can result in equipment damage.

The following table describes the different steps to de-install a TMC2 cartridge from the controller:

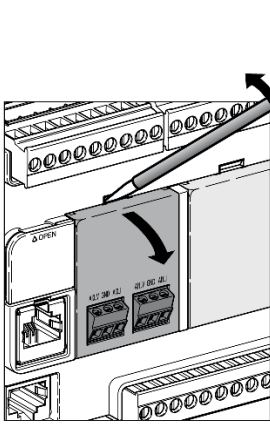
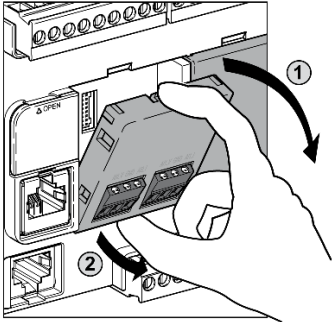
Step	Action
1	Disconnect all power from all equipment, including connected devices, prior to removing a cartridge.
2	<p data-bbox="289 285 1167 337">Press the locking clip on the top of the cartridge with an insulated screwdriver and pull up the cartridge gently.</p> 
3	<p data-bbox="289 816 760 837">Remove by hand the cartridge from the controller.</p> 

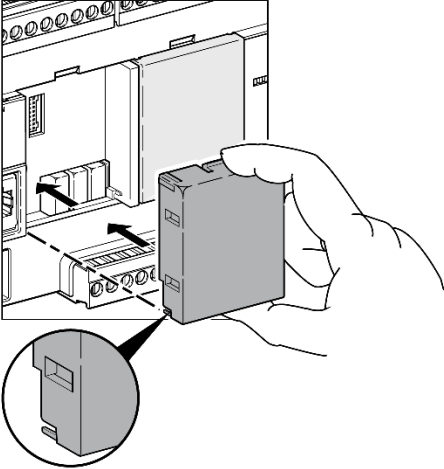
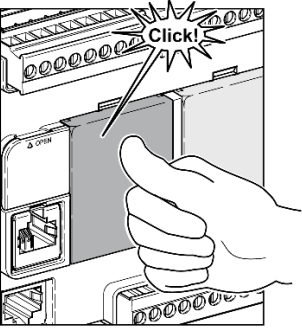
Step	Action
4	<p data-bbox="316 203 857 227">Place the cartridge slot cover in the slot on the controller.</p> 
5	<p data-bbox="316 751 830 776">Push the cartridge slot cover into the slot until it clicks.</p> 

Section 2.3

TMC2 Electrical Requirements

What Is in This Section?

This section contains the following topics:

Topic	Page
Wiring Best Practices	31
Grounding the M221 System	34

Wiring Best Practices

Overview

This section describes the wiring guidelines and associated best practices to be respected when using the M221 Logic Controller system.

DANGER

HAZARD OF ELECTRIC SHOCK, EXPLOSION OR ARC FLASH

- Disconnect all power from all equipment including connected devices prior to removing any covers or doors, or installing or removing any accessories, hardware, cables, or wires except under the specific conditions specified in the appropriate hardware guide for this equipment.
- Always use a properly rated voltage sensing device to confirm the power is off where and when indicated.
- Replace and secure all covers, accessories, hardware, cables, and wires and confirm that a proper ground connection exists before applying power to the unit.
- Use only the specified voltage when operating this equipment and any associated products.

Failure to follow these instructions will result in death or serious injury.

WARNING

LOSS OF CONTROL

- The designer of any control scheme must consider the potential failure modes of control paths and, for certain critical control functions, provide a means to achieve a safe state during and after a path failure. Examples of critical control functions are emergency stop and overtravel stop, power outage and restart.
- Separate or redundant control paths must be provided for critical control functions.
- System control paths may include communication links. Consideration must be given to the implications of unanticipated transmission delays or failures of the link.
- Observe all accident prevention regulations and local safety guidelines.¹
- Each implementation of this equipment must be individually and thoroughly tested for proper operation before being placed into service.

Failure to follow these instructions can result in death, serious injury, or equipment damage.

¹ For additional information, refer to NEMA ICS 1.1 (latest edition), "Safety Guidelines for the Application, Installation, and Maintenance of Solid State Control" and to NEMA ICS 7.1 (latest edition), "Safety Standards for Construction and Guide for Selection, Installation and Operation of Adjustable-Speed Drive Systems" or their equivalent governing your particular location.

Wiring Guidelines

The following rules must be applied when wiring a M221 Logic Controller system:

- I/O and communication wiring must be kept separate from the power wiring. Route these 2 types of wiring in separate cable ducting.
- Verify that the operating conditions and environment are within the specification values.
- Use proper wire sizes to meet voltage and current requirements.
- Use copper conductors (required).
- Use twisted pair, shielded cables for analog, and/or fast I/O.
- Use twisted pair, shielded cables for networks, and fieldbus.

Use shielded, properly grounded cables for all analog and high-speed inputs or outputs and communication connections. If you do not use shielded cable for these connections, electromagnetic interference can cause signal degradation. Degraded signals can cause the controller or attached modules and equipment to perform in an unintended manner.

WARNING

UNINTENDED EQUIPMENT OPERATION

- Use shielded cables for all fast I/O, analog I/O and communication signals.
- Ground cable shields for all analog I/O, fast I/O and communication signals at a single point¹.
- Route communication and I/O cables separately from power cables.

Failure to follow these instructions can result in death, serious injury, or equipment damage.

¹Multipoint grounding is permissible if connections are made to an equipotential ground plane dimensioned to help avoid cable shield damage in the event of power system short-circuit currents.

For more details, refer to Grounding Shielded Cables (*see page 34*).

NOTE: Surface temperatures may exceed 60 °C (140 °F). To conform to IEC 61010 standards, route primary wiring (wires connected to power mains) separately and apart from secondary wiring (extra low voltage wiring coming from intervening power sources). If that is not possible, double insulation is required such as conduit or cable gains.

The cartridge connectors are not removable.

NOTICE







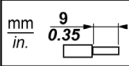

INOPERABLE EQUIPMENT

Do not attempt to remove the connectors from the cartridge.

Failure to follow these instructions can result in equipment damage.

Rules for Non-Removable Screw Terminal Block

The following table shows the cable types and wire sizes for a **3.81 mm (0.15 in.)** pitch non-removable screw terminal block:

					
mm in.	mm ²	AWG	mm ²	mm ²	mm ²
	0.14...1.5	25...16	0.14...1.5	0.25...1.5	0.25...0.5
			23...16	23...20	2 x 0.5
					2 x 20
		N•m	0.20		
Ø 2,5 mm (0.1 in.)		lb-in	1.77		

The use of copper conductors is required.

DANGER

LOOSE WIRING CAUSES ELECTRIC SHOCK

Tighten connections in conformance with the torque specifications.

Failure to follow these instructions will result in death or serious injury.

DANGER

FIRE HAZARD

- Use only the correct wire sizes for the current capacity of the I/O channels and power supplies.
- For relay output (2 A) wiring, use conductors of at least 0.5 mm² (AWG 20) with a temperature rating of at least 80 °C (176 °F).
- For common conductors of relay output wiring (7 A), or relay output wiring greater than 2 A, use conductors of at least 1.0 mm² (AWG 16) with a temperature rating of at least 80 °C (176 °F).

Failure to follow these instructions will result in death or serious injury.

Grounding the M221 System

Overview

To help minimize the effects of electromagnetic interference, cables carrying the fast I/O, analog I/O, and field bus communication signals must be shielded.

WARNING

UNINTENDED EQUIPMENT OPERATION

- Use shielded cables for all fast I/O, analog I/O, and communication signals.
- Ground cable shields for all fast I/O, analog I/O, and communication signals at a single point¹.
- Route communications and I/O cables separately from power cables.

Failure to follow these instructions can result in death, serious injury, or equipment damage.

¹Multipoint grounding is permissible if connections are made to an equipotential ground plane dimensioned to help avoid cable shield damage in the event of power system short-circuit currents.

The use of shielded cables requires compliance with the following wiring rules:

- For protective ground connections (PE), metal conduit or ducting can be used for part of the shielding length, provided there is no break in the continuity of the ground connections. For functional ground (FE), the shielding is intended to attenuate electromagnetic interference and the shielding must be continuous for the length of the cable. If the purpose is both functional and protective, as is often the case for communication cables, the cable must have continuous shielding.
- Wherever possible, keep cables carrying one type of signal separate from the cables carrying other types of signals or power.

Protective Ground (PE) on the Backplane

The protective ground (PE) is connected to the conductive backplane by a heavy-duty wire, usually a braided copper cable with the maximum allowable cable section.

Shielded Cables Connections

Cables carrying the fast I/O, analog I/O, and field bus communication signals must be shielded. The shielding must be securely connected to ground. The fast I/O and analog I/O shields may be connected either to the functional ground (FE) or to the protective ground (PE) of your M221 Logic Controller. The field bus communication cable shields must be connected to the protective ground (PE) with a connecting clamp secured to the conductive backplane of your installation.

The shielding of the Modbus cable must be connected to the protective ground (PE).

DANGER

ELECTRIC SHOCK

Make sure that Modbus cables are securely connected to the protective ground (PE).

Failure to follow these instructions will result in death or serious injury.

Protective Ground (PE) Cable Shielding

To ground the shield of a cable through a grounding clamp:

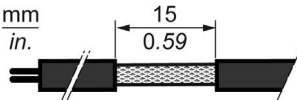
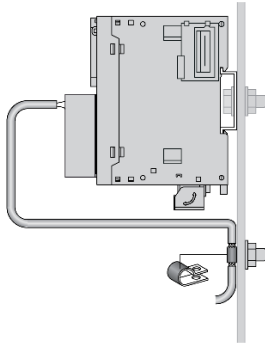
Step	Description	
1	Strip the shielding for a length of 15 mm (0.59 in.)	
2	Attach the cable to the conductive backplane plate by attaching the grounding clamp to the stripped part of the shielding as close as possible to the M221 Logic Controller system base.	

NOTE: The shielding must be clamped securely to the conductive backplane to ensure a good contact.

Functional Ground (FE) Cable Shielding

To connect the shield of a cable through the Grounding Bar:

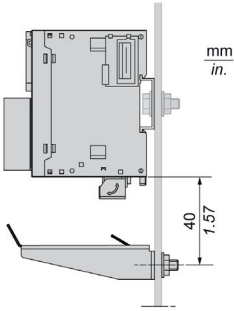
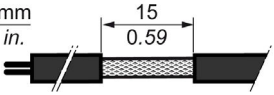
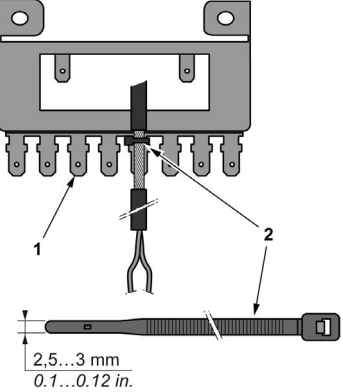
Step	Description	
1	Install the Grounding Bar directly on the conductive backplane below the M221 Logic Controller system as illustrated.	
2	Strip the shielding for a length of 15 mm (0.59 in).	
3	Tightly clamp on the blade connector (1) using nylon fastener (2) (width 2.5...3 mm (0.1...0.12 in.)) and appropriate tool.	

NOTE: Use the TM2XMTGB Grounding Bar exclusively for Functional Ground (FE) connections.

⚠ WARNING

ACCIDENTAL DISCONNECTION FROM PROTECTIVE GROUND (PE)

- Do not use the TM2XMTGB Grounding Plate to provide a protective ground (PE).
- Use the TM2XMTGB Grounding Plate only to provide a functional ground (FE).

Failure to follow these instructions can result in death, serious injury, or equipment damage.

Part II

TMC2 Standard Cartridges

What Is in This Part?

This part contains the following chapters:

Chapter	Chapter Name	Page
3	TMC2AI2 Analog Voltage, Current Inputs	39
4	TMC2TI2 Analog Temperature Inputs	45
5	TMC2AQ2V Analog Voltage Outputs	51
6	TMC2AQ2C Analog Current Outputs	57
7	TMC2SL1 Serial Line	63

Chapter 3

TMC2AI2 Analog Voltage, Current Inputs

Overview

This chapter describes the TMC2AI2 cartridge, its characteristics, and its connections.

What Is in This Chapter?

This chapter contains the following topics:

Topic	Page
TMC2AI2 Presentation	40
TMC2AI2 Characteristics	41
TMC2AI2 Wiring Diagram	43

TMC2AI2 Presentation

Overview

The following features are integrated into the TMC2AI2 cartridge:

- 2 analog inputs (voltage or current)
- non-removable screw terminal block, 3.81 mm (0.15 in.) pitch

Main Characteristics

Characteristic	Value	
	Signal type	Current
Number of input channels	2	
Input range	0...10 Vdc	0...20 mA 4...20 mA
Resolution	12 bits (4096 steps)	
Connection type	3.81 mm (0.15 in.) pitch, non-removable screw terminal block	
Weight	15 g (0.53 oz)	

TMC2AI2 Characteristics

Introduction

This section provides a general description of the TMC2AI2 cartridge characteristics.

⚠ WARNING

UNINTENDED EQUIPMENT OPERATION

Do not exceed any of the rated values specified in the environmental and electrical characteristics tables.

Failure to follow these instructions can result in death, serious injury, or equipment damage.

NOTE: For important safety information and the environment characteristics of the TMC2 cartridges, see the M221 Logic Controller Hardware Guide.

Connectors

The following diagram shows a TMC2AI2 cartridge marking and connectors:

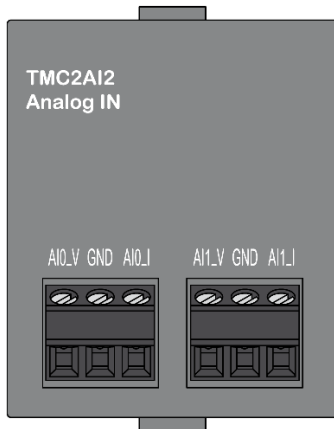

Input Characteristics

The following table describes the cartridge input characteristics:

Characteristics		Value	
	Signal Type	Voltage	Current
Rated input range		0...10 Vdc	0...20 mA 4...20 mA
Input impedance		> 1 M Ω	< 250 Ω
Sample duration time		10 ms per enabled channel	
Input type		single-ended	
Operating mode		self-scan	
Conversion mode		SAR type	
Maximum accuracy at ambient temperature: 25 °C (77 °F)		\pm 0.1 % of full scale	
Temperature drift		\pm 0.02 % of full scale per 1 °C (1.8 °F)	
Repeatability after stabilization time		\pm 0.5 % of full scale	
Non-linearity		\pm 0.01 % of full scale	
Maximum input deviation		\pm 1.0 % of full scale	
Digital resolution		12 bits (4096 steps)	
Input value of LSB		2.44 mV (0...10 Vdc range)	4.88 μ A (0...20 mA range) 3.91 μ A (4...20 mA range)
Data type in application program		scalable from -32768 to 32767	
Input data out of detection range		yes	
Noise resistance	maximum temporary deviation during perturbations	\pm 4.0 % of the full scale maximum when EMC perturbation is applied to the power and I/O wiring	
	cable type and maximum length	twisted-pair shielded < 30 m (98.4 ft)	
	crosstalk (maximum)	1 LSB	
Isolation between inputs and internal logic		not isolated	
Maximum continuous overload allowed (without damage)		13 Vdc	40 mA
Input filter		software filter: 0...10 s (with 0.1 s increment)	

TMC2AI2 Wiring Diagram

Introduction

This cartridge has a non-removable screw terminal block for the connection of the inputs.

Wiring

See Wiring Best Practices (*see page 31*).

Wiring Diagram

The following figure shows an example of the voltage and current input connection:

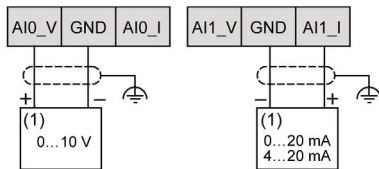

(1): Current/Voltage analog output device

NOTE: Each input can be connected to either a voltage or current input.

Chapter 4

TMC2TI2 Analog Temperature Inputs

Overview

This chapter describes the TMC2TI2 cartridge, its characteristics, and its connections.

What Is in This Chapter?

This chapter contains the following topics:

Topic	Page
TMC2TI2 Presentation	46
TMC2TI2 Characteristics	47
TMC2TI2 Wiring Diagram	50

TMC2TI2 Presentation

Overview

The following features are integrated into the TMC2TI2 cartridge:

- 2 analog temperature inputs (thermocouple or RTD)
- non-removable screw terminal block, 3.81 mm (0.15 in.) pitch

Main Characteristics

Characteristic		Value	
	Signal type	Thermocouple	3 wires RTD
Number of input channels		2	
Input range		type: K, J, R, S, B, E, T, N, C	type: Pt100, Pt1000, Ni100, Ni1000
Resolution		14 bits	
Connection type		3.81 mm (0.15 in.) pitch, non-removable screw terminal block	
Weight		15 g (0.53 oz)	

TMC2T12 Characteristics

Introduction

This section provides a general description of the TMC2T12 cartridge characteristics.

⚠ WARNING

UNINTENDED EQUIPMENT OPERATION

Do not exceed any of the rated values specified in the environmental and electrical characteristics tables.

Failure to follow these instructions can result in death, serious injury, or equipment damage.

NOTE: For important safety information and the environment characteristics of the TMC2 cartridges, see the M221 Logic Controller Hardware Guide.

Connectors

The following diagram shows a TMC2T12 cartridge marking and connectors:

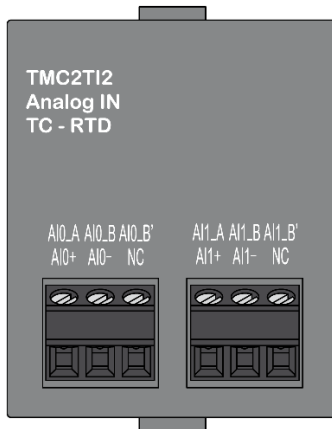

Input Characteristics

The following table describes the cartridge input characteristics:

Characteristics		Value	
	Signal Type	Thermocouple	3 wires RTD
Rated input range		thermocouple type: K: -200...+1300 °C (-328...+2372 °F) J: -200...+1000 °C (-328...+1832 °F) R: 0...+1760 °C (+32...+3200 °F) S: 0...+1760 °C (+32...+3200 °F) B: 0...+1820 °C (+32...+3308 °F) E: -200...+800 °C (-328...+1472 °F) T: -200...+400 °C (-328...+752 °F) N: -200...+1300 °C (-328...+2372 °F) C: 0...+2315 °C (+32...+4199 °F)	RTD type: Pt100: -200...+850 °C (-328...+1562 °F) Pt1000: -200...+600 °C (-328...+1112 °F) Ni100: -60...+180 °C (-76...+356 °F) Ni1000: -60...+180 °C (-76...+356 °F)
Input impedance		> 1 MΩ	
Sample duration time		125 ms per enabled channel	250 ms per enabled channel
Input type		single-ended	
Operating mode		self-scan	
Conversion mode		SAR type	
Maximum accuracy		K, J, E, T, N: ± 0.1 % of full scale at ambient temperature: 25 °C (77 °F) ± 0.4 % of full scale at temperature < 0 °C (32 °F) R, S: ± 6 °C (10.8 °F) of full scale for measured temperature range: 0...200 °C (32...392 °F) B: not specified C: ± 0.1 % of full scale at ambient temperature: 25 °C (77 °F)	± 0.1 % of full scale at ambient temperature: 25 °C (77 °F)
Temperature drift		± 0.02 % of full scale per 1 °C (1.8 °F)	
Repeatability after stabilization time		± 0.5 % of full scale	
Non-linearity		± 0.01 % of full scale	

Characteristics		Value	
	Signal Type	Thermocouple	3 wires RTD
Maximum input deviation		± 1.0 % of full scale	
Digital resolution		thermocouple type: K: 15000 steps J: 12000 steps R: 17600 steps S: 17600 steps B: 18200 steps E: 10000 steps T: 6000 steps N: 15000 steps C: 23150 steps	RTD type: Pt100: 10500 steps Pt1000: 8000 steps Ni100: 2400 steps Ni1000: 2400 steps
Input value of LSB		0.1 °C (0.18 °F)	
Data type in application program		scalable from -32768 to 32767	
Input data out of detection range		yes	
Noise resistance	maximum temporary deviation during perturbations	± 4.0 % of the full scale maximum when EMC perturbation is applied to the power and I/O wiring	
	cable type and maximum length	shielded < 30 m (98.4 ft)	
	crosstalk (maximum)	1 LSB	
Isolation between inputs and internal logic		not isolated	
Maximum continuous overload allowed (without damage)		13 Vdc	40 mA
Input filter		software filter: 0...10 s (with 0.1 s increment)	
Behavior when the temperature sensor is disconnected or broken		input value = upper limit	

TMC2TI2 Wiring Diagram

Introduction

This cartridge has a non-removable screw terminal block for the connection of the inputs.

Wiring

See Wiring Best Practices (*see page 31*).

Wiring Diagram

The following figure shows an example of RTD and thermocouple probe connection:

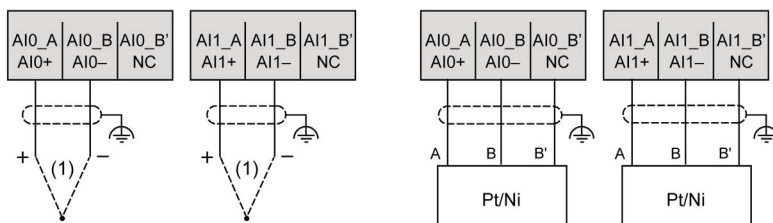

(1): Thermocouple

NOTE: Each input can be connected to either an RTD or thermocouple probe.

⚠ WARNING

UNINTENDED EQUIPMENT OPERATION

Do not connect wires to unused terminals and/or terminals indicated as “No Connection (N.C.)”.

Failure to follow these instructions can result in death, serious injury, or equipment damage.

Chapter 5

TMC2AQ2V Analog Voltage Outputs

Overview

This chapter describes the TMC2AQ2V cartridge, its characteristics, and its connections.

What Is in This Chapter?

This chapter contains the following topics:

Topic	Page
TMC2AQ2V Presentation	52
TMC2AQ2V Characteristics	53
TMC2AQ2V Wiring Diagram	55

TMC2AQ2V Presentation

Overview

The following features are integrated into the TMC2AQ2V cartridge:

- 2 analog voltage outputs
- non-removable screw terminal block, 3.81 mm (0.15 in.) pitch

Main Characteristics

Characteristic		Value
	Signal type	Voltage
Number of output channels		2
Output range		0...10 Vdc
Resolution		12 bits (4096 steps)
Connection type		3.81 mm (0.15 in.) pitch, non-removable screw terminal block
Weight		15 g (0.53 oz)

TMC2AQ2V Characteristics

Introduction

This section provides a general description of the characteristics of the TMC2AQ2V cartridge.

⚠ WARNING

UNINTENDED EQUIPMENT OPERATION

Do not exceed any of the rated values specified in the environmental and electrical characteristics tables.

Failure to follow these instructions can result in death, serious injury, or equipment damage.

NOTE: For important safety information and the environment characteristics of the TMC2 cartridges, see the M221 Logic Controller Hardware Guide.

Connectors

The following diagram shows a TMC2AQ2V cartridge marking and connectors:

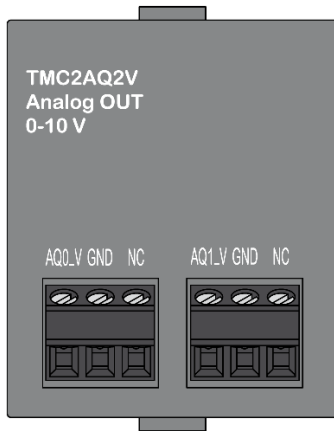

Output Characteristics

The following table describes the cartridge output characteristics:

Characteristics		Value
	Signal Type	Voltage
Rated output range		0...10 Vdc
Load impedance		> 2 K Ω
Application load type		resistive load
Conversion time		20 ms
Total output system transfer time		40 ms
Maximum accuracy at ambient temperature: 25 °C (77 °F)		\pm 0.3 % of full scale
Temperature drift		\pm 0.02 % of full scale per 1 °C (1.8 °F)
Repeatability after stabilization time		\pm 0.4 % of full scale
Non-linearity		\pm 0.01 % of full scale
Overshoot		0 %
Maximum output deviation		\pm 1.0 % of full scale (including ripple)
Digital resolution		12 bits (4096 steps)
Output value of LSB		2.44 mV
Data type in application program		0...4095 scalable from -32768 to 32767
Noise resistance	maximum temporary deviation during perturbations	\pm 4.0 % of the full scale maximum when EMC perturbation is applied to the power and I/O wiring
	cable type and maximum length	twisted-pair shielded
		< 30 m (98.4 ft)
crosstalk (maximum)	1 LSB	
Isolation between outputs and internal logic		not isolated

TMC2AQ2V Wiring Diagram

Introduction

This cartridge has a non-removable screw terminal block for the connection of the outputs.

Wiring

See Wiring Best Practices (*see page 31*).

Wiring Diagram

The following figure shows an example of the voltage output connection:

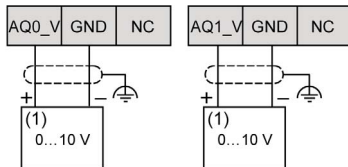

(1): Voltage analog input device

⚠ WARNING

UNINTENDED EQUIPMENT OPERATION

Do not connect wires to unused terminals and/or terminals indicated as “No Connection (N.C.)”.

Failure to follow these instructions can result in death, serious injury, or equipment damage.

Chapter 6

TMC2AQ2C Analog Current Outputs

Overview

This chapter describes the TMC2AQ2C cartridge, its characteristics, and its connections.

What Is in This Chapter?

This chapter contains the following topics:

Topic	Page
TMC2AQ2C Presentation	58
TMC2AQ2C Characteristics	59
TMC2AQ2C Wiring Diagram	61

TMC2AQ2C Presentation

Overview

The following features are integrated into the TMC2AQ2C cartridge:

- 2 analog current outputs
- non-removable screw terminal block, 3.81 mm (0.15 in.) pitch

Main Characteristics

Characteristic		Value
	Signal type	Current
Number of output channels		2
Output range		4...20 mA
Resolution		12 bits (4096 steps)
Connection type		3.81 mm (0.15 in.) pitch, non-removable screw terminal block
Weight		15 g (0.53 oz)

TMC2AQ2C Characteristics

Introduction

This section provides a general description of the TMC2AQ2C cartridge characteristics.

⚠ WARNING

UNINTENDED EQUIPMENT OPERATION

Do not exceed any of the rated values specified in the environmental and electrical characteristics tables.

Failure to follow these instructions can result in death, serious injury, or equipment damage.

NOTE: For important safety information and the environment characteristics of the TMC2 cartridges, see the M221 Logic Controller Hardware Guide.

Connectors

The following diagram shows a TMC2AQ2C cartridge marking and connectors:

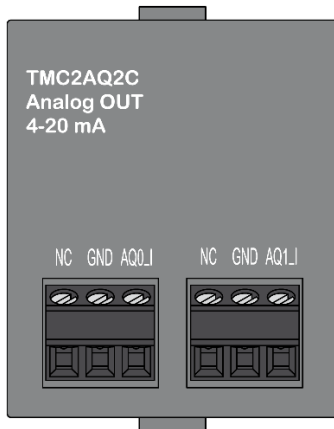

Output Characteristics

The following table describes the cartridge output characteristics:

Characteristics		Value
	Signal Type	Current
Rated output range		4...20 mA
Load impedance		< 500 Ω
Application load type		resistive load
Conversion time		20 ms
Total output system transfer time		40 ms
Maximum accuracy at ambient temperature: 25 °C (77 °F)		± 0.3 % of full scale
Temperature drift		± 0.02 % of full scale per 1 °C (1.8 °F)
Repeatability after stabilization time		± 0.4 % of full scale
Non-linearity		± 0.01 % of full scale
Overshoot		0 %
Maximum output deviation		± 1.0 % of full scale (including ripple)
Digital resolution		12 bits (4096 steps)
Output value of LSB		3.91 μ A
Data type in application program		0...4095 scalable from -32768 to 32767
Noise resistance	maximum temporary deviation during perturbations	± 4.0 % of the full scale maximum when EMC perturbation is applied to the power and I/O wiring
	cable type and maximum length	twisted-pair shielded
		< 30 m (98.4 ft)
crosstalk (maximum)	1 LSB	
Isolation between outputs and internal logic		not isolated

TMC2AQ2C Wiring Diagram

Introduction

This cartridge has a non-removable screw terminal block for the connection of the outputs.

Wiring

See Wiring Best Practices (*see page 31*).

Wiring Diagram

The following figure shows an example of the current output connection:

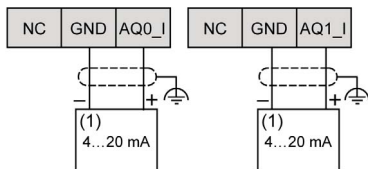

(1): Current analog input device

⚠ WARNING

UNINTENDED EQUIPMENT OPERATION

Do not connect wires to unused terminals and/or terminals indicated as “No Connection (N.C.)”.

Failure to follow these instructions can result in death, serious injury, or equipment damage.

Chapter 7

TMC2SL1 Serial Line

Overview

This chapter describes the TMC2SL1 cartridge, its characteristics, and its connections.

What Is in This Chapter?

This chapter contains the following topics:

Topic	Page
TMC2SL1 Presentation	64
TMC2SL1 Characteristics	65
TMC2SL1 Wiring Diagram	67

TMC2SL1 Presentation

Overview

The following features are integrated into the TMC2SL1 cartridge:

- 1 serial line (RS232 or RS485)
- non-removable screw terminal block, 3.81 mm (0.15 in.) pitch

Main Characteristics

Characteristic	Value	
Standard	Serial line RS232	Serial line RS485
Number of channels	1	
Connection type	3.81 mm (0.15 in.) pitch, non-removable screw terminal block	
Weight	15 g (0.53 oz)	

TMC2SL1 Characteristics

Introduction

This section provides a general description of the TMC2SL1 cartridge characteristics.

⚠ WARNING

UNINTENDED EQUIPMENT OPERATION

Do not exceed any of the rated values specified in the environmental and electrical characteristics tables.

Failure to follow these instructions can result in death, serious injury, or equipment damage.

NOTE: For important safety information and the environment characteristics of the TMC2 cartridges, see the M221 Logic Controller Hardware Guide.

Connectors

The following diagram shows a TMC2SL1 cartridge marking and connectors:

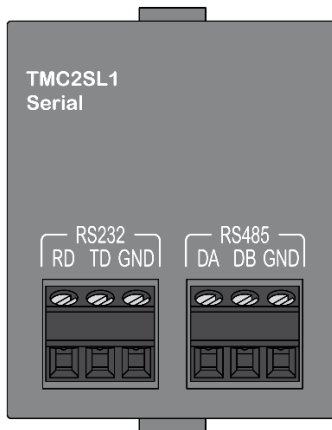

Serial Line Characteristics

The following table describes the cartridge serial line characteristics:

Characteristics		Value	
Software configurable standard		RS232	RS485
Baudrate		1200...115200 bps	
Wires		Rx, Tx, common	DA, DB, common
Protocol selection		software programmable	
Line polarization		–	software programmable
Line end adapter in the cartridge		no	
cable	type	shielded	
	length	< 3 m (9.8 ft)	< 15 m (49.2 ft)
Isolation between lines and internal logic		not isolated	

TMC2SL1 Wiring Diagram

Introduction

This cartridge has a non-removable screw terminal block for the connection of the serial line wires.

Wiring

See Wiring Best Practices (*see page 31*).

Wiring Diagram

The following figure shows an example of RS232 serial line connection:

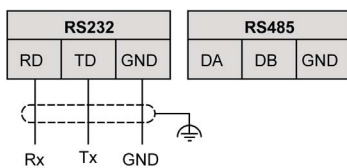

The following figure shows an example of RS485 serial line connection:

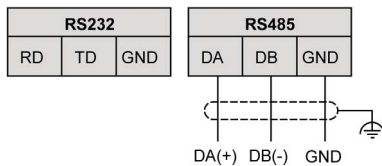

NOTE: Only 1 serial line (RS232 or RS485) can be connected to the cartridge.

NOTE: Only 1 TMC2SL1 cartridge is managed per logic controller.

Part III

TMC2 Application Cartridges

What Is in This Part?

This part contains the following chapters:

Chapter	Chapter Name	Page
8	TMC2HOIS01 Hoisting	71
9	TMC2PACK01 Packaging	77
10	TMC2CONV01 Conveying	83

Chapter 8

TMC2HOIS01 Hoisting

Overview

This chapter describes the TMC2HOIS01 cartridge, its characteristics, and its connections.

What Is in This Chapter?

This chapter contains the following topics:

Topic	Page
TMC2HOIS01 Presentation	72
TMC2HOIS01 Characteristics	73
TMC2HOIS01 Wiring Diagram	75

TMC2HOIS01 Presentation

Overview

The following features are integrated into the TMC2HOIS01 cartridge:

- 2 analog inputs (voltage or current) for hoisting load cells
- non-removable screw terminal block, 3.81 mm (0.15 in.) pitch

Main Characteristics

Characteristic	Value	
	Signal type	Current
Number of input channels	2	
Input range	0...10 Vdc	0...20 mA 4...20 mA
Resolution	12 bits (4096 steps)	
Connection type	3.81 mm (0.15 in.) pitch, non-removable screw terminal block	
Weight	15 g (0.53 oz)	

TMC2HOIS01 Characteristics

Introduction

This section provides a general description of the TMC2HOIS01 cartridge characteristics.

⚠ WARNING

UNINTENDED EQUIPMENT OPERATION

Do not exceed any of the rated values specified in the environmental and electrical characteristics tables.

Failure to follow these instructions can result in death, serious injury, or equipment damage.

NOTE: For important safety information and the environment characteristics of the TMC2 cartridges, see the M221 Logic Controller Hardware Guide.

Connectors

The following diagram shows a TMC2HOIS01 cartridge marking and connectors:

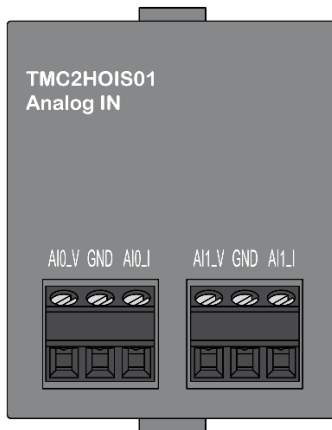

Input Characteristics

The following table describes the cartridge input characteristics:

Characteristics		Value	
	Signal Type	Voltage	Current
Rated input range		0...10 Vdc	0...20 mA 4...20 mA
Input impedance		> 1 M Ω	< 250 Ω
Sample duration time		10 ms per enabled channel	
Input type		single-ended	
Operating mode		self-scan	
Conversion mode		SAR type	
Maximum accuracy at ambient temperature: 25 °C (77 °F)		\pm 0.1 % of full scale	
Temperature drift		\pm 0.02 % of full scale per 1 °C (1.8 °F)	
Repeatability after stabilization time		\pm 0.5 % of full scale	
Non-linearity		\pm 0.01 % of full scale	
Maximum input deviation		\pm 1.0 % of full scale	
Digital resolution		12 bits (4096 steps)	
Input value of LSB		2.44 mV (0...10 Vdc range)	4.88 μ A (0...20 mA range) 3.91 μ A (4...20 mA range)
Data type in application program		scalable from -32768 to 32767	
Input data out of detection range		yes	
Noise resistance	maximum temporary deviation during perturbations	\pm 4.0 % of the full scale maximum when EMC perturbation is applied to the power and I/O wiring	
	cable type and maximum length	twisted-pair shielded < 30 m (98.4 ft)	
	crosstalk (maximum)	1 LSB	
Isolation between inputs and internal logic		not isolated	
Maximum continuous overload allowed (without damage)		13 Vdc	40 mA
Input filter		software filter: 0...10 s (with 0.1 s increment)	

TMC2HOIS01 Wiring Diagram

Introduction

This cartridge has a non-removable screw terminal block for the connection of the inputs.

Wiring

See Wiring Best Practices (*see page 31*).

Wiring Diagram

The following figure shows an example of the voltage and current input connection:

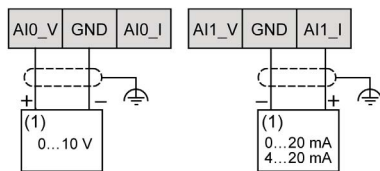

(1): Current/Voltage analog output device

NOTE: Each input can be connected to either a voltage or current input.

Chapter 9

TMC2PACK01 Packaging

Overview

This chapter describes the TMC2PACK01 cartridge, its characteristics, and its connections.

What Is in This Chapter?

This chapter contains the following topics:

Topic	Page
TMC2PACK01 Presentation	78
TMC2PACK01 Characteristics	79
TMC2PACK01 Wiring Diagram	81

TMC2PACK01 Presentation

Overview

The following features are integrated into the TMC2PACK01 cartridge:

- 2 analog inputs (voltage or current) for packaging
- non-removable screw terminal block, 3.81 mm (0.15 in.) pitch

Main Characteristics

Characteristic		Value	
	Signal type	Voltage	Current
Number of input channels		2	
Input range		0...10 Vdc	0...20 mA 4...20 mA
Resolution		12 bits (4096 steps)	
Connection type		3.81 mm (0.15 in.) pitch, non-removable screw terminal block	
Weight		15 g (0.53 oz)	

TMC2PACK01 Characteristics

Introduction

This section provides a general description of the TMC2PACK01 cartridge characteristics.

⚠ WARNING

UNINTENDED EQUIPMENT OPERATION

Do not exceed any of the rated values specified in the environmental and electrical characteristics tables.

Failure to follow these instructions can result in death, serious injury, or equipment damage.

NOTE: For important safety information and the environment characteristics of the TMC2 cartridges, see the M221 Logic Controller Hardware Guide.

Connectors

The following diagram shows a TMC2PACK01 cartridge marking and connectors:

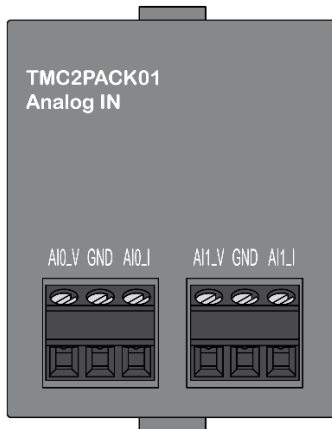

Input Characteristics

The following table describes the cartridge input characteristics:

Characteristics		Value	
	Signal Type	Voltage	Current
Rated input range		0...10 Vdc	0...20 mA 4...20 mA
Input impedance		> 1 M Ω	< 250 Ω
Sample duration time		10 ms per enabled channel	
Input type		single-ended	
Operating mode		self-scan	
Conversion mode		SAR type	
Maximum accuracy at ambient temperature: 25 °C (77 °F)		\pm 0.1 % of full scale	
Temperature drift		\pm 0.02 % of full scale per 1 °C (1.8 °F)	
Repeatability after stabilization time		\pm 0.5 % of full scale	
Non-linearity		\pm 0.01 % of full scale	
Maximum input deviation		\pm 1.0 % of full scale	
Digital resolution		12 bits (4096 steps)	
Input value of LSB		2.44 mV (0...10 Vdc range)	4.88 μ A (0...20 mA range) 3.91 μ A (4...20 mA range)
Data type in application program		scalable from -32768 to 32767	
Input data out of detection range		yes	
Noise resistance	maximum temporary deviation during perturbations	\pm 4.0 % of the full scale maximum when EMC perturbation is applied to the power and I/O wiring	
	cable type and maximum length	twisted-pair shielded < 30 m (98.4 ft)	
	crosstalk (maximum)	1 LSB	
Isolation between inputs and internal logic		not isolated	
Maximum continuous overload allowed (without damage)		13 Vdc	40 mA
Input filter		software filter: 0...10 s (with 0.1 s increment)	

TMC2PACK01 Wiring Diagram

Introduction

This cartridge has a non-removable screw terminal block for the connection of the inputs.

Wiring

See Wiring Best Practices (*see page 31*).

Wiring Diagram

The following figure shows an example of the voltage and current input connection:

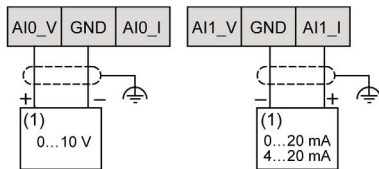

(1): Current/Voltage analog output device

NOTE: Each input can be connected to either a voltage or current input.

Chapter 10

TMC2CONV01 Conveying

Overview

This chapter describes the TMC2CONV01 cartridge, its characteristics, and its connections.

What Is in This Chapter?

This chapter contains the following topics:

Topic	Page
TMC2CONV01 Presentation	84
TMC2CONV01 Characteristics	85
TMC2CONV01 Wiring Diagram	87

TMC2CONV01 Presentation

Overview

The following features are integrated into the TMC2CONV01 cartridge:

- 1 serial line (RS232 or RS485) for conveying
- non-removable screw terminal block, 3.81 mm (0.15 in.) pitch

Main Characteristics

Characteristic	Value	
	Serial line RS232	Serial line RS485
Number of channels	1	
Connection type	3.81 mm (0.15 in.) pitch, non-removable screw terminal block	
Weight	15 g (0.53 oz)	

TMC2CONV01 Characteristics

Introduction

This section provides a general description of the TMC2CONV01 cartridge characteristics.

⚠ WARNING

UNINTENDED EQUIPMENT OPERATION

Do not exceed any of the rated values specified in the environmental and electrical characteristics tables.

Failure to follow these instructions can result in death, serious injury, or equipment damage.

NOTE: For important safety information and the environment characteristics of the TMC2 cartridges, see the M221 Logic Controller Hardware Guide.

Connectors

The following diagram shows a TMC2CONV01 cartridge marking and connectors:

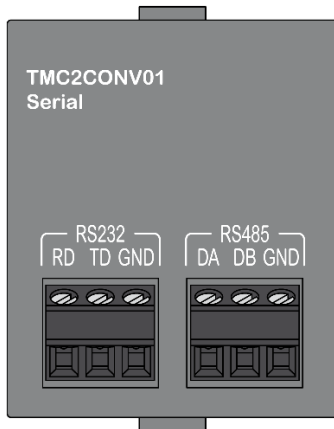

Serial Line Characteristics

The following table describes the cartridge serial line characteristics:

Characteristics		Value	
Software configurable standard		RS232	RS485
Baudrate		1200...115200 bps	
Wires		Rx, Tx, common	DA, DB, common
Protocol selection		software programmable	
Line polarization		–	software programmable
Line end adapter in the cartridge		no	
cable	type	shielded	
	length	< 3 m (9.8 ft)	< 15 m (49.2 ft)
Isolation between lines and internal logic		not isolated	

TMC2CONV01 Wiring Diagram

Introduction

This cartridge has a non-removable screw terminal block for the connection of the serial line wires.

Wiring

See Wiring Best Practices (*see page 31*).

Wiring Diagram

The following figure shows an example of RS232 serial line connection:

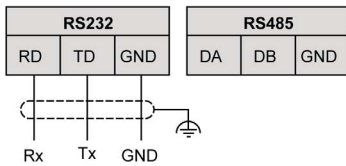

The following figure shows an example of RS485 serial line connection:

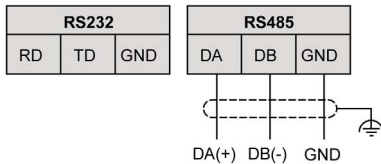

NOTE: Only 1 serial line (RS232 or RS485) can be connected to the cartridge.

NOTE: Only 1 TMC2CONV01 cartridge is managed per logic controller.

Glossary



M

Modbus

The protocol that allows communications between many devices connected to the same network.

P

PE

(Protective Earth) A common grounding connection to help avoid the hazard of electric shock by keeping any exposed conductive surface of a device at earth potential. To avoid possible voltage drop, no current is allowed to flow in this conductor (also referred to as *protective ground* in North America or as an equipment grounding conductor in the US national electrical code).



C

cartridge

compatibility, *16*

description, *15*

features, *15*

TMC2, *37, 69*

TMC2AI2, *39*

TMC2AQ2C, *57*

TMC2AQ2V, *51*

TMC2CONV01, *83*

TMC2HOIS01, *71*

TMC2PACK01, *77*

TMC2SL1, *63*

TMC2TI2, *45*

certifications and standards, *20*

compatibility

cartridge, *16*

D

description

cartridge, *15*

E

environment, *19*

F

features

cartridge, *15*

G

Grounding, *34*

R

RS232, *63*

RS485, *63*

T

TMC2

cartridge, *37, 69*

TMC2AI2

cartridge, *39*

TMC2AQ2C

cartridge, *57*

TMC2AQ2V

cartridge, *51*

TMC2CONV01

cartridge, *83*

TMC2HOIS01

cartridge, *71*

TMC2PACK01

cartridge, *77*

TMC2SL1

cartridge, *63*

TMC2TI2

cartridge, *45*

W

wiring, *31*

