

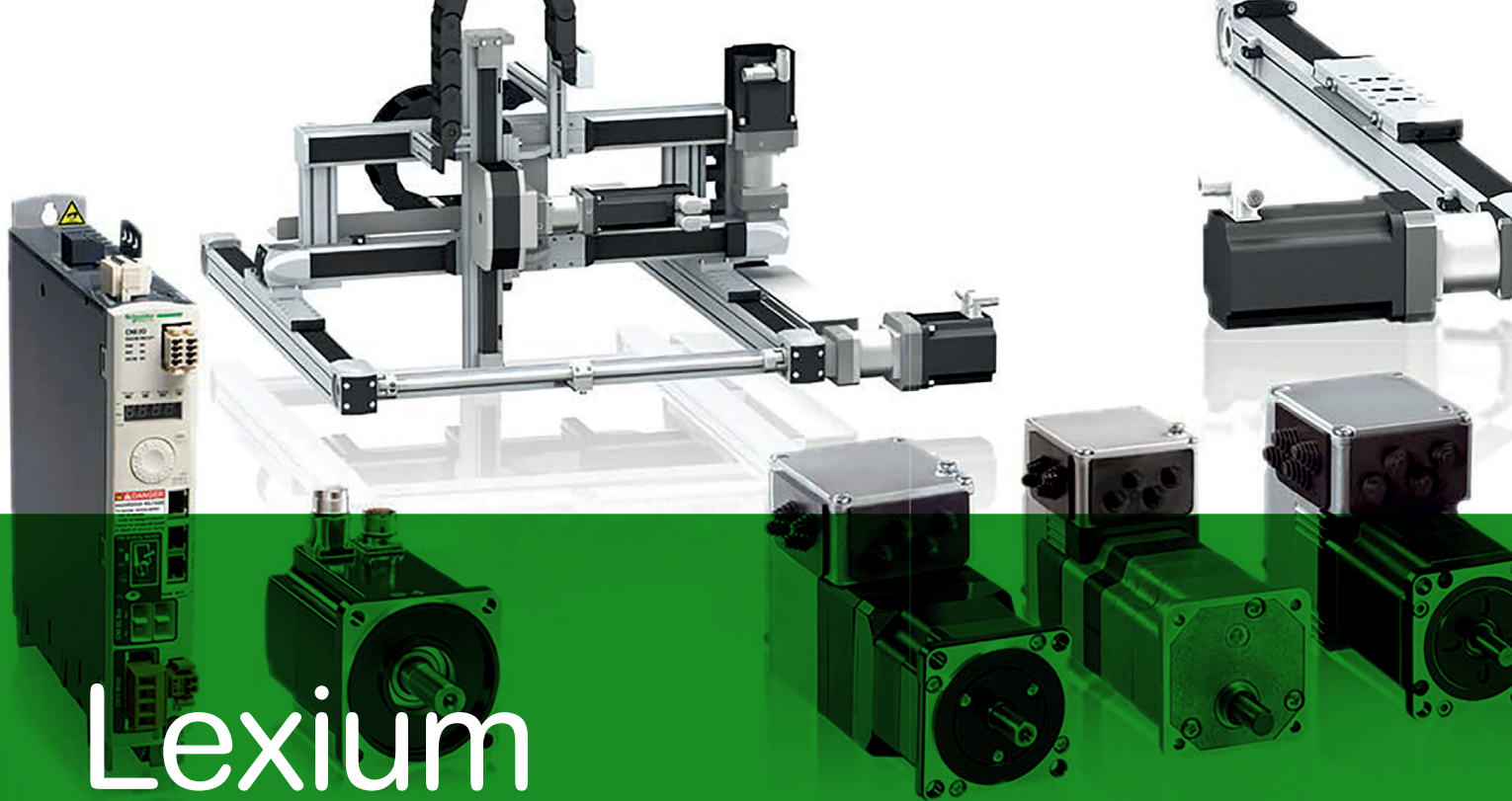

Lexium 28 & Motors

Lexium 28 servo drives and
BCH2 servo motors



Discover [Lexium](#)

Advanced motion control and robotics

Lexium servo drives, motors, and robotics series are designed for a broad range of motion-centric machines. From single-axis to high-performance multi-axis machines, the **Lexium** range enables high-speed movements and precise positioning in packaging, material handling, material working, electronics, and food and beverage applications.

Explore our offer

- [Lexium](#) Servo Drives and Motors
- [Lexium](#) Integrated Servo Drives
- [Lexium](#) Robotics
- [Lexium](#) Stepper Drives

Quick access to product information

Get technical information about your product

References

Modicon TM3
I/O expansion modules for Modicon controllers
Analog I/O modules

Number and type of channels	Input range	Output range	Resolution	Input format (mA)	Reference	Weight (kg)
2 voltage inputs	-15...+15 VDC 0...20 mA r.t. 20 mA	16.00V or 12.00V r.t.	16.00V or 12.00V r.t.	0/20mA	TM3AI2H	0.110
4 voltage inputs	-15...+15 VDC 0...20 mA r.t. 20 mA	16.00V or 12.00V r.t.	16.00V or 12.00V r.t.	0/20mA	TM3AI4	0.100
4 differential temperature inputs (I ² C, R, S, T, N, C, L, E, C)	Thermopiles or RTD (PT100, NI1000, PT100, PT200)	16.00V or 12.00V r.t.	16.00V or 12.00V r.t.	0/20mA	TM3TI4	0.110
4 differential temperature inputs (I ² C, R, S, T, N, C, L, E, C)	Thermopiles or RTD (PT100, NI1000, PT100, PT200)	16.00V or 12.00V r.t.	16.00V or 12.00V r.t.	0/20mA	TM3TI4	0.110
8 self-diagnosing	-15...+15 VDC	16.00V or 12.00V r.t.	16.00V or 12.00V r.t.	0/20mA	TM3AI8	0.110

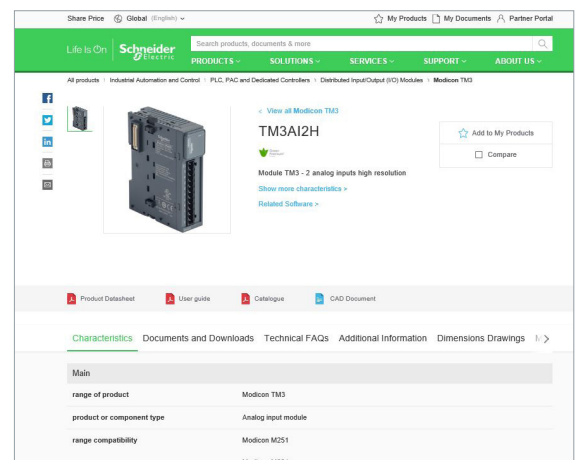

Each commercial reference presented in a catalog contains a hyperlink. Click on it to obtain the technical information of the product:

- Characteristics, Dimensions and drawings, Mounting and clearance, Connections and schemas, Performance curves
- Product image, Instruction sheet, User guide, Product certifications, End of life manual

Find your catalog

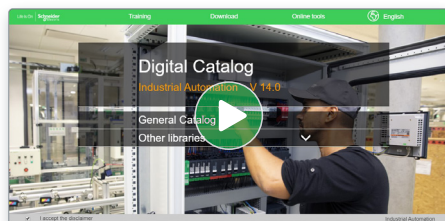

- > With just 3 clicks, you can access the Industrial Automation and Control catalogs, in both English and French
- > Consult digital automation catalogs at [Digi-Cat Online](#)

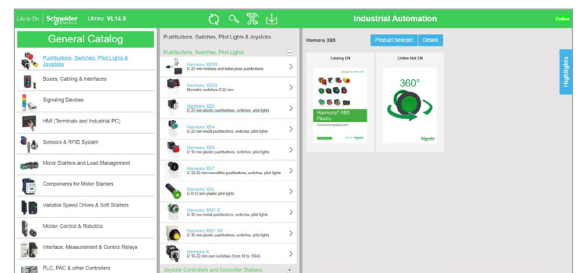

- Up-to-date catalogs
- Embedded product selectors, 360° pictures
- Optimized search by commercial references

Select your training



- > Find the right [Training](#) for your needs on our Global website
- > Locate the training center with the selector tool, using this [link](#)

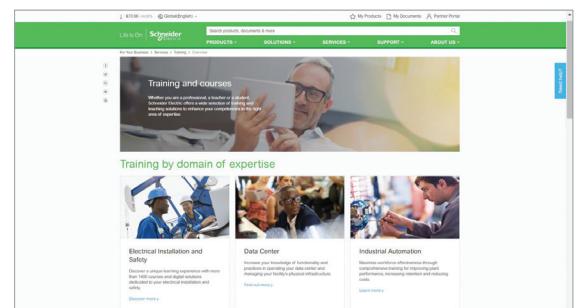

General content

Lexium 28 & Motors

General overview

- Empowering industrial OEMs for the digital era [page 2](#)
- Lexium 28 & BCH2: optimized servo bundles for compact machines..... [page 3](#)
- Intuitive commissioning & programming..... [page 3](#)

Lexium 28 servo drives

- Applications [page 4](#)
- Embedded safety function STO [page 4](#)
- Functions [page 5](#)
- Combinations: servo drives and servo motors [page 6](#)
- Description [page 8](#)
- References, dimensions and weights [page 9](#)

■ Connection accessories, accessories

- References [page 10](#)

■ Configuration tools

- SoMove Setup software
 - Presentation, references [page 11](#)
- Multi-loader configuration tool
 - Presentation, references [page 11](#)

■ Internal and external braking resistors

- Presentation, references [page 12](#)

■ Communication

- On CANopen/CANmotion fieldbus
 - Presentation, references [page 13](#)
- On EtherCAT fieldbus
 - Presentation, references [page 14](#)
- On Sercos III fieldbus
 - Presentation, references [page 15](#)

■ Additional EMC input filters for servo drives

- Presentation, references [page 16](#)

■ Motor starters

- Presentation, combination [page 17](#)

■ Protection using fuses

- Combination [page 17](#)

BCH2 servo motors

- Presentation [page 18](#)
- Description [page 18](#)
- References [page 19](#)
- Dimensions, weight [page 20](#)

■ Options for BCH2 servo motors

- Integrated holding brake
 - Presentation, references [page 21](#)
- Integrated encoder
 - Presentation [page 21](#)

■ Connection components for BCH2 servo motors

- References: power cordsets, connector kits [page 22](#)
- References: encoder cordsets, connector kits [page 23](#)
- Selection of connector kit according to BCH2 motor type..... [page 23](#)

■ Index

- Product reference index..... [page 24](#)

Empowering industrial OEMs for the digital era

To be competitive in today's digital era, machine builders must be innovative. Smart machines, those that are better connected, more flexible, more efficient, and safe, are enabling machine builders to innovate in ways never before possible.

- > EcoStruxure™ Machine, our open, interoperable, IoT-enabled system architecture helps you build smarter machines and equipment faster, making your business more efficient, profitable, and sustainable.
- > EcoStruxure Machine brings together key technologies for product connectivity and edge control on premises, and cloud technologies to provide analytics and digital services.
- > EcoStruxure Machine helps you bring more innovation and added value to your customers throughout the entire machine life cycle

Lexium 28 is part of EcoStruxure Machine™

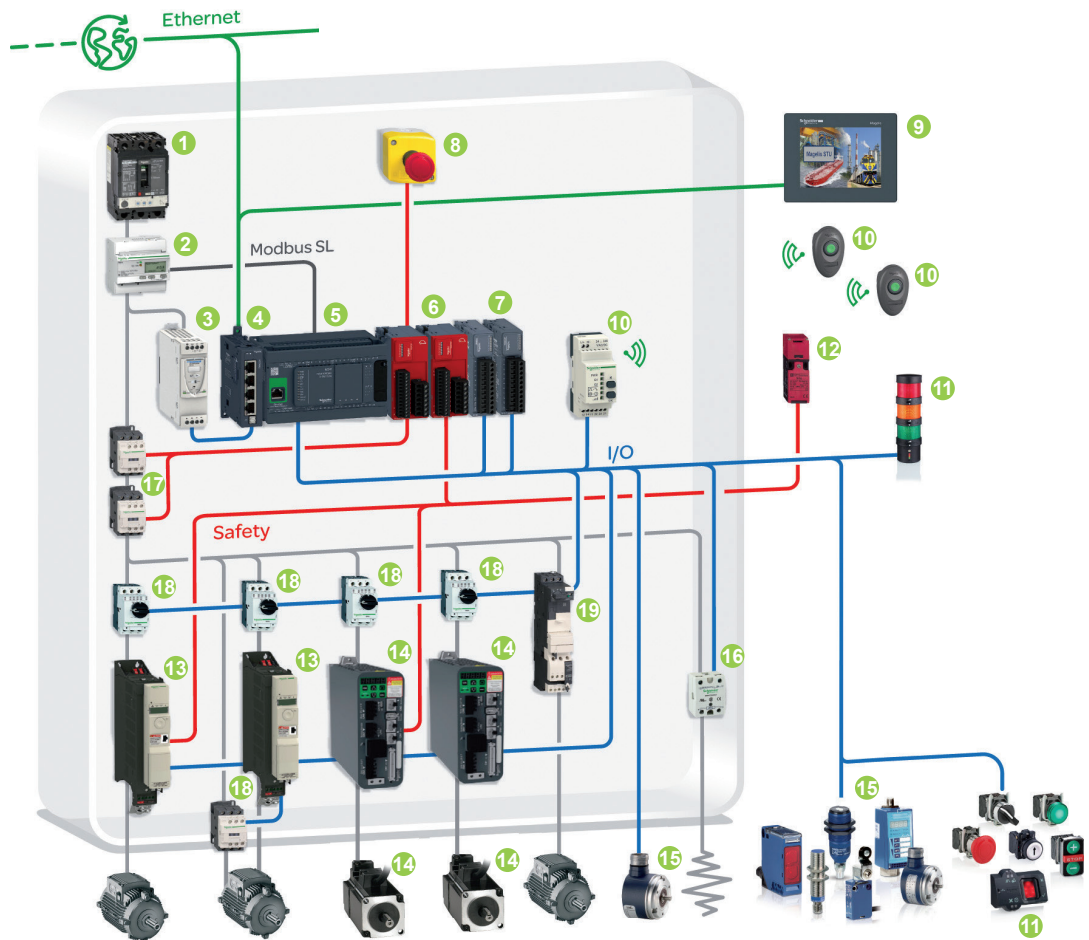

Solution Breakdown (1)

- | | |
|---|--|
| <ul style="list-style-type: none"> 1 ComPact NSX circuit breaker 2 Acti 9 iEM3000 energy meter 3 Modicon switch mode power supply 4 Modicon TM4 Ethernet switch module 5 Modicon M241 logic controller 6 Modicon TM3 functional safety module 7 Modicon TM3 I/O expansion module 8 Harmony XALK emergency stop 9 Harmony STO/STU HMI 10 Harmony XB5R wireless and batteryless pushbutton, configurable access point | <ul style="list-style-type: none"> 11 Harmony XVB modular beacons and tower lights 12 Preventa XCS safety switch 13 Altivar 32 variable speed drive 14 Lexium 28 Servo Drive & BCH2 servo motor 15 Telemecanique sensors® proximity & photoelectric sensors, limit switches 16 Harmony solid-state relay 17 TeSys Control Relays 18 TeSys GV2L motor circuit breaker 19 TeSys Ultra All-in-one motor starters |
|---|--|



(1) Please refer to our catalogs on [Digi-Cat](#) (click to open Digi-Cat on line)

Lexium 28 & BCH2: optimized servo bundles for compact machines

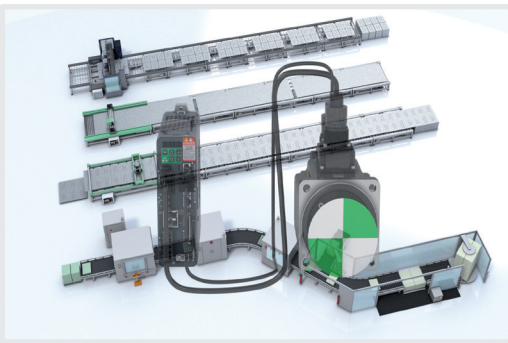

Servo range with best-in-class performance

The predefined servo bundles of Lexium 28 servo drive & BCH2 servo motor are optimized for easy integration & commissioning in your machine. It includes standard interfaces, embedded safety function and DC-bus sharing.

- > CANopen / CANmotion, EtherCAT and Sercos
- > Pulse Train

Reduce your time to market

- > Automatic tuning and motor identification
- > PLC open motion library

Increase profitability

- > Designed for optimized & cost effective solutions
- > Drive embedded safety function: Safe-Torque-Off

Improve efficiency

- > Energy efficient because of DC-bus sharing
- > Predefined servo bundles to fit each machine type

Simplify integration & maintenance

LXM28A●●● servo drives

- > Standard fieldbus interface CANopen / CANmotion
- > Pulse-train-input (PTI) and Pulse-train-output (PTO) interfaces
- > Digital input interface to control simple movements directly by the servo drive: Position sequence mode
- > Analog input interface +/-10 V for speed control mode and torque control mode
- > Servo drive embedded safety function Safe-Torque-Off (STO)

LXM28E●●● servo drives

- > Standard fieldbus interface EtherCAT
- > Pulse-train-output (PTO) interface
- > Digital input interface for sensor signals such as fast capture signals, limit switches and homing sensors
- > Servo drive embedded safety function Safe-Torque-Off (STO)

LXM28S●●● servo drives

- > Standard fieldbus interface Sercos
- > Pulse-train-output (PTO) interface
- > Digital input interface for sensor signals such as fast capture signals, limit switches and homing sensors
- > Servo drive embedded safety function Safe-Torque-Off (STO)

Achieve benchmark performance while increasing profitability

Lexium 28 and Lexium BCH2, the optimized servo bundle for motion control solutions

- > Cost effective
- > Energy efficient
- > Embedded safety

Intuitive commissioning & programming



EcoStruxure Machine Expert configuration software



SoMove Setup software

EcoStruxure Machine Expert - One software for commissioning and programming

EcoStruxure Machine Expert is the universal programming software for machines automated by EcoStruxure Machine controllers.

Simple navigation that requires only fewer clicks delivers a more efficient engineering process. The programming, visualization, and commissioning are handled in a single intuitive tool.

EcoStruxure Machine Expert software includes a 21 day free trial. After this period a license is required to continue to benefit from EcoStruxure Machine Expert. Please consult on our [web site](#)

SoMove Setup software

In addition to EcoStruxure Machine Expert the SoMove Setup software can be used for the commissioning of Lexium 28. This could be done in just the same way as it is on other Schneider Electric drives and starters, to configure, adjust, debug, and maintain the drive. SoMove can be downloaded from our [web site](#)

Multi-loader tool

The Multi-loader tool enables configurations to be copied from a PC or a servo drive and loaded onto another servo drive. The servo drives do not need to be powered-up. See [page 11](#).

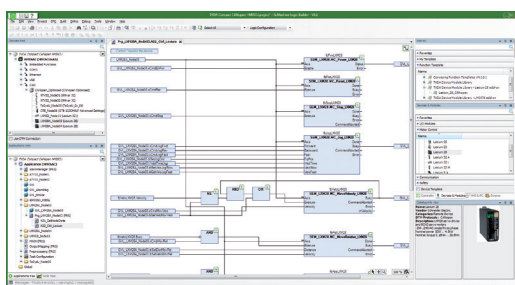

Programming, visualization, and commissioning with EcoStruxure Machine Expert configuration software



Material working application



Material handling application

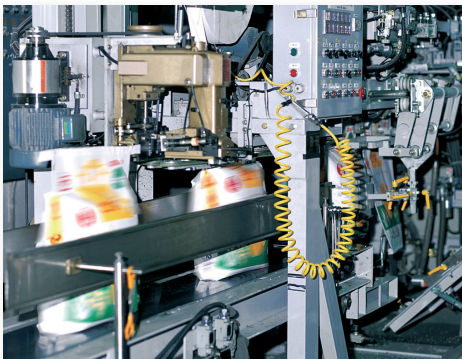

Packaging application



Textile application



Guard monitoring safety function held by Lexium 28 servo drives. More details for Safety Solution on our [web site](#)

Presentation

The Lexium 28 range is defined by AC-servo drives Lexium 28 for combination with AC-servo motors BCH2.

- The Lexium 28 range offers predetermined combinations to suit the requirements of motion control applications, and optimize installation's performance.
- The combinations of servo motors with servo drives are based on the power class: both servo motor and servo drive have the same power class.
- The bundle of a servo drive with its related servo motor is designed to cover a nominal power from 0.05 kW up to 4.5 kW (0.067 up to 6.03 hp) with 200..240 V mains supply voltage
- The Lexium 28 servo drives are delivered without EMC filter, the EMC immunity is reached with additional EMC filter.
- The Lexium 28 servo drives have degree of protection IP20.
- BCH2 motors provide a nominal torque from 0.16 Nm to 28.6 Nm and a nominal speed of from 1,000 to 3,000 rpm, depending on the model. They are suitable for a wide variety of applications due to the different levels of motor inertia offered.

Compact range

The compact dimensions of Lexium 28 servo drives mean they fit very easily into small spaces, thus reducing the size of the installation and the cost of the equipment.

Applications

- Material working (multi-axis machines, cutting machines, etc.)
- Material handling (conveying, palletizers, warehousing, etc.)
- Assembly line (clamping, etc.)
- Packaging
- Printing
- Winding and unwinding

Flexibility

Lexium 28 servo drives have digital and analog I/O as standard, and an encoder interface for BCH2 servo motors, and embed a communication interface for being controlled, depending on model:

- CANopen/CANmotion field bus interface on LXM28A●●● servo drives
- EtherCAT field bus interface on LXM28E●●●
- Sercos III field bus interface on LXM28S●●●

Lexium 28 servo drives incorporate numerous functions, including auto-tuning, position, speed, torque control.

LXM28A●●● drives can be used with drive embedded "position sequence mode", controlled through digital input signals. This open communication concept enables integration into numerous different control system architectures.

Mounting and maintenance

Connecting the servo drives is simplified by identified plug-in connectors, which are easily accessed, mainly on the front panel and also on top of the drive .

Embedded safety function STO

The Lexium 28 range of servo drives is an integral part of the Machine safety system "Preventa solutions for efficient machine safety" with its drive embedded Safe-Torque-Off (STO) function. This function meets the requirements of SIL 2 according IEC 61800-5-2, IEC 62061 and IEC 61508 as well as up to category 3 and PLd according to EN ISO 13849-1. It simplifies the setup of installations requiring complex safety equipment and improves performance during maintenance operations.

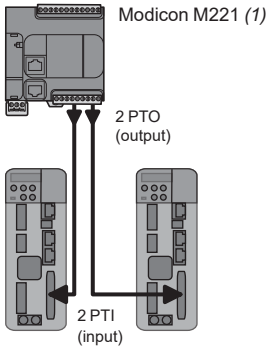

Example of architecture with two **LXM28A●●●** servo drives controlled by Modicon M221 logic controller

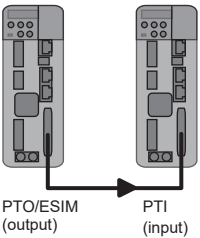

Example of a **LXM28A●●●** servo drive via PTO/ESIM interface, controlling another **LXM28A●●●** servo drive with PTI interface

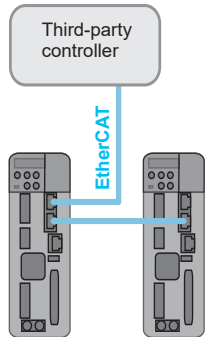

Example of **EtherCAT** architecture with two **LXM28E●●●** servo drives controlled by a third-party controller

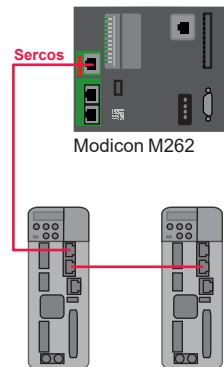

Example of **Sercos** architecture with two **LXM28S●●●** servo drives controlled by a Modicon M262 Motion controller (2)

PTO: pulse-train-output
 ESIM: encoder simulation output. The servo drive provides its motor position through this electrical interface to another device.
 PTI: pulse-train-input interface

Main functions of Lexium 28 servo drives

- Automatic motor identification by the servo drive: the technical data related to the motor is provided from the motor to the drive via the encoder connection cable.
- Filtering: Anti-vibration function for suppression of resonance frequencies of the power train connected with the moving mass of the application
- Monitoring functions:
 - Status monitoring, I/O monitoring
 - Log function to memorize alarm and warning messages (in the drive)
 - Reset function of alarms and warnings
 - Monitoring of drive variables related to motor control and closed loop control
- **Additional main function:** Movement control with digital input interface directly in the servo drive:
 - Relative or absolute positioning mode
 - Velocity mode
 - Torque control mode
 - Position sequence mode: a sequence of up to 32 movements, controlled by a digital input interface

Control via I/O interface or fieldbus

LXM28A●●● servo drives are controlled through “CN4 CAN” interface with a CANopen/CANmotion fieldbus control interface. They can also be controlled through numerous digital and analog signals, accessible by “CN1 I/O” interface:

- 2 digital inputs for high performance position capture
- 8 digital inputs
- 5 digital outputs
- 2 analog inputs
- 2 analog outputs
- 1 digital input channel (2 wires) for the safety function “Safe-Torque-Off”

LXM28E●●● servo drives are controlled through “CN4 Eth” interface with an EtherCAT fieldbus control interface. They can also be controlled through numerous digital and analog signals, accessible by “CN1 I/O” interface:

- 2 digital inputs for high performance position capture
- 8 digital inputs
- 5 digital outputs

LXM28S●●● servo drives are controlled through “CN4 Sercos” interface with a Sercos III fieldbus control interface. They can also be controlled through numerous digital and analog signals, accessible by “CN1 I/O” interface:

- 2 digital inputs for high performance position capture
- 8 digital inputs
- 4 digital outputs
- 1 digital input channel (2 wires) for the safety function “Safe-Torque-Off”

Drive functions activated by commissioning software or directly by the HMI interface

- Jog mode: Velocity movement
- “Easy tuning” one-button tuning mode: this function is used to optimize application performance.
- Additional tuning function, which can be activated by the SoMove Setup commissioning software or by the HMI interface: “Comfort tuning” with predefined settings for different mechanical systems such as spindle axes (e.g. portal axes), transportation belt, vertical axes (e.g. cantilever axes)

Operating modes

Operating modes for LXM28A●●●/E●●●/S●●● servo drives via PTI/PTO interface

- Lexium 28 servo drives movement can be managed by a machine controller (Modicon M221 logic controller) with pulse-train-output (PTO) interface or the PTO interface from another (Lexium 28) servo drive.
- The corresponding pulse-train-input (PTI) of LXM28A●●●/E●●●/S●●● servo drives is then electrically connected to CN1 I/O interface.

Operating modes for LXM28A●●● servo drives (via the CANopen/CANmotion fieldbus), for LXM28E●●● servo drives (via EtherCAT field bus) and for LXM28S●●● servo drives (via the Sercos III fieldbus):

- Homing
- Point-to-point mode
- Position gear mode
- Cyclic synchronous position mode, cyclic synchronous velocity mode, cyclic synchronous torque mode

(1) Consult catalog Modicon M221 logic controller Ref. [DIA3ED2140106EN](#)
 (2) Consult catalog Modicon M262 logic/motion controller Ref. [DIA3ED2180503EN](#)

Lexium 28 & Motors

Lexium 28 servo drives and BCH2 servo motors



BCH2 servo motors and Lexium 28 servo drives combinations												
Available power output		Nominal speed of rotation	Nominal torque		Maximum peak torque		Servo motor reference	Inertia (without holding brake)	Motor inertia type	Servo drive reference Fieldbus interface		
kW	hp	rpm	Nm	ft lbf	Nm	ft lbf		kgcm ²		CANopen	Ethercat	Sercos 3
Single-phase supply voltage: 200/240 VAC												
0.05	0.067	3,000	0.16	0.11	0.48	0.35	BCH2MBA53●●●5C	0.054	Medium	LXM28AU5M3X	LXM28EU5M3X	LXM28SUA5M3X
0.1	0.13	3,000	0.32	0.23	0.96	0.70	BCH2MB013●●●5C	0.075	Medium	LXM28AU01M3X	LXM28EU01M3X	LXM28SU01M3X
0.2	0.26	3,000	0.64	0.47	1.92	1.41	BCH2LD023●●●5C	0.16	Low	LXM28AU02M3X	LXM28EU02M3X	LXM28SU02M3X
0.3	0.41	1,000	2.86	2.10	8.59	6.33	BCH2MM031●●●6C	6.63	Medium			
0.4	0.53	3,000	1.27	0.93	3.81	2.81	BCH2LD043●●●5C	0.27	Low	LXM28AU04M3X	LXM28EU04M3X	LXM28SU04M3X
0.4	0.53	3,000	1.27	0.93	3.81	2.81	BCH2LF043●●●5C	0.67	Low			
0.5	0.67	2,000	2.39	1.76	7.16	5.28	BCH2MM052●●●6C	6.63	Medium			
0.6	0.80	1,000	5.73	4.22	17.19	12.67	BCH2MM061●●●6C	6.63	Medium	LXM28AU07M3X	LXM28EU07M3X	LXM28SU07M3X
0.75	1.00	3,000	2.39	1.76	7.16	5.28	BCH2HF073●●●5C	1.54	High			
0.75	1.00	3,000	2.39	1.76	7.16	5.28	BCH2LF073●●●5C	1.19	Low			
0.85	1.13	1,500	5.39	3.97	13.8	10.17	BCH2MM081●●●6C	13.5	Medium			
0.9	1.21	1,000	8.59	6.33	25.77	19.01	BCH2MM091●●●6C	9.7	Medium			
1	1.34	3,000	3.18	2.34	9.54	7.03	BCH2LH103●●●6C	2.4	Low	LXM28AU10M3X	LXM28EU10M3X	LXM28SU10M3X
1	1.34	2,000	4.77	3.51	14.3	10.54	BCH2MM102●●●6C	6.63	Medium			
1	1.34	2,000	4.77	3.51	14.3	10.54	BCH2HM102●●●6C	8.53	High			
1.5	2.01	2,000	7.16	5.28	21.48	15.84	BCH2MM152●●●6C	9.7	Medium	LXM28AU15M3X	LXM28EU15M3X	LXM28SU15M3X
3 phase supply voltage: 200/240 VAC												
0.05	0.067	3,000	0.16	0.11	0.48	0.35	BCH2MBA53●●●5C	0.054	Medium	LXM28AU5M3X	LXM28EU5M3X	LXM28SUA5M3X
0.1	0.13	3,000	0.32	0.23	0.96	0.70	BCH2MB013●●●5C	0.075	Medium	LXM28AU01M3X	LXM28EU01M3X	LXM28SU01M3X
0.2	0.26	3,000	0.64	0.47	1.92	1.41	BCH2LD023●●●5C	0.16	Low	LXM28AU02M3X	LXM28EU02M3X	LXM28SU02M3X
0.3	0.41	1,000	2.86	2.10	8.59	6.33	BCH2MM031●●●6C	6.63	Medium			
0.4	0.53	3,000	1.27	0.93	3.81	2.81	BCH2LD043●●●5C	0.27	Low	LXM28AU04M3X	LXM28EU04M3X	LXM28SU04M3X
0.4	0.53	3,000	1.27	0.93	3.81	2.81	BCH2LF043●●●5C	0.67	Low			
0.5	0.67	2,000	2.39	1.76	7.16	5.28	BCH2MM052●●●6C	6.63	Medium			
0.6	0.80	1,000	5.73	4.22	17.19	12.67	BCH2MM061●●●6C	6.63	Medium	LXM28AU07M3X	LXM28EU07M3X	LXM28SU07M3X
0.75	1.00	3,000	2.39	1.76	7.16	5.28	BCH2HF073●●●5C	1.54	High			
0.75	1.00	3,000	2.39	1.76	7.16	5.28	BCH2LF073●●●5C	1.19	Low			
0.85	1.13	1,500	5.39	3.97	13.8	10.17	BCH2MM081●●●6C	13.5	Medium			
0.9	1.21	1,000	8.59	6.33	25.77	19.01	BCH2MM091●●●6C	9.7	Medium			
1	1.34	3,000	3.18	2.34	9.54	7.03	BCH2LH103●●●6C	2.4	Low	LXM28AU10M3X	LXM28EU10M3X	LXM28SU10M3X
1	1.34	2,000	4.77	3.51	14.3	10.54	BCH2MM102●●●6C	6.63	Medium			
1	1.34	2,000	4.77	3.51	14.3	10.54	BCH2HM102●●●6C	1.54	High			
1.5	2.01	2,000	7.16	5.28	21.48	15.84	BCH2MM152●●●6C	9.7	Medium	LXM28AU15M3X	LXM28EU15M3X	LXM28SU15M3X
2.0	2.68	3,000	6.37	4.69	19.1	14.08	BCH2LH203●●●6C	4.28	Low			
2.0	2.68	2,000	9.55	7.04	28.65	21.13	BCH2MM202●●●6C	13.5	Medium	LXM28AU20M3X	LXM28EU20M3X	LXM28SU20M3X
2.0	2.68	2,000	9.55	7.04	28.65	21.13	BCH2MR202●●●6C	26.5	Medium			
2.0	2.68	2,000	9.55	7.04	28.65	21.13	BCH2HR202●●●6C	34.67	High			
3.0	4.02	1,500	19.1	14.08	57.29	42.25	BCH2MR301●●●6C	53.56	Medium	LXM28AU30M3X	LXM28EU30M3X	LXM28SU30M3X
3.0	4.02	2,000	14.32	10.56	42.97	31.69	BCH2MR302●●●6C	53.56	Medium			
3.5	4.69	2,000	16.7	12.31	50.3	37.09	BCH2MR352●●●6C	53.56	Medium	LXM28AU45M3X	LXM28EU45M3X	LXM28SU45M3X
4.5	6.03	1,500	28.65	21.13	71.62	52.82	BCH2MR451●●●6C	73.32	Medium			

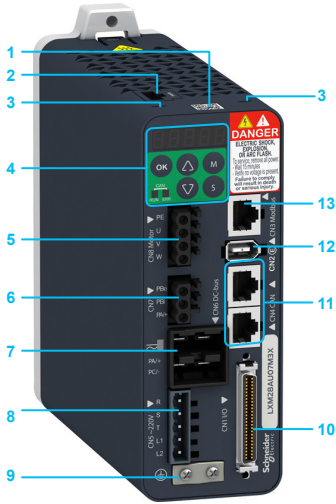

LXM28A●●●

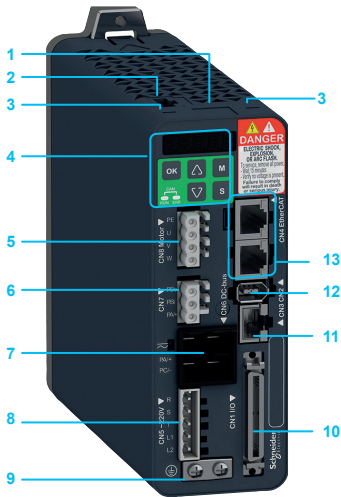

LXM28E●●●

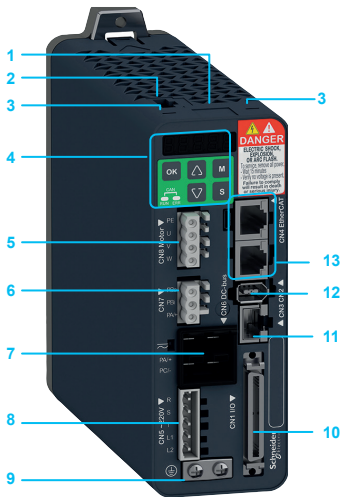

LXM28S●●●

Description

On Lexium 28 servo drive top side

- 1 QR code for access to detailed technical data, wiring guide, and installation guide
- 2 Removable terminal (1) for STO function (marked "CN9")
- 3 Slot for application name plate

On Lexium 28 servo drive front side:

- 4 MI interface, 7-segment display, 5 buttons (OK, mode, set, value up, value down) and servo drive status LED
- 5 Removable terminal block (1) for motor connection (marked "CN8 Motor")
- 6 Removable terminal block (1) for braking resistor connection (marked "CN7")
- 7 DC-bus connector with status LED "DC-bus charged" (marked "CN6 DC-bus")
- 8 Removable terminal block (1), 5 terminals (R, S, T, L1, L2) for connecting the 220 V ~ power supply (marked "CN5 ~ 220 V")
- 9 Protected earth connector (marked "⊕")
- 10 Input/output interface connector (marked "CN1 I/O")

On LXM28A●●● servo drive front side

- 11 2x RJ45 connectors for CANopen/CANmotion fieldbus connection (marked "CN4 CAN")
- 12 Connector for motor encoder: 20-bit single-turn absolute encoder, type ServoSense® (marked "CN2 ⊕")
- 13 RJ45 connector for Modbus serial link (marked "CN3 Modbus")

On LXM28E●●● servo drive front side

- 11 RJ45 connector for Modbus serial link (marked "CN3 Modbus")
- 12 Connector for motor encoder: 20-bit single-turn absolute encoder, type ServoSense® (marked "CN2 ⊕")
- 13 2x RJ45 connectors for EtherCAT fieldbus connection (marked "CN4")

On LXM28S●●● servo drive front side

- 11 RJ45 connector for Modbus serial link (marked "CN3 Modbus")
- 12 Connector for motor encoder: 20-bit single-turn absolute encoder, type ServoSense® (marked "CN2 ⊕")
- 13 2x RJ45 connectors for Sercos III fieldbus connection (marked "CN4")

(1) Removable spring terminals are supplied with each Lexium 28 servo drive

Lexium 28 servo drives												
References												
To order a Lexium 28 servo drive, make up the reference as follows:												
Example	L	X	M	2	8	A	U	A	5	M	3	X
Lexium 28 AC servo drive	L	X	M	2	8							
Interface	CANopen and CANmotion fieldbus					A						
	EtherCAT fieldbus					E						
	Sercos III fieldbus					S						
Power	50 W (0.067 hp)					U	A	5				
	100 W (0.13 hp)					U	0	1				
	200 W (0.26 hp)					U	0	2				
	400 W (0.53 hp)					U	0	4				
	750 W (1.00 hp)					U	0	7				
	1 kW (1.34 hp)					U	1	0				
	1.5 kW (2.01 hp)					U	1	5				
	2 kW (2.68 hp)					U	2	0				
	3 kW (4.02 hp)					U	3	0				
	4.5 kW (6.03 hp)					U	4	5				
Supply voltage	200...240 VAC (1)									M	3	X

(1) Lexium 28 servo drives are delivered without EMC filter

Dimensions and weight				
Servo drive reference	Housing size	Dimensions (overall)		Weight kg/ lb
		Width x Height x Depth (W x H x D)		
		mm	in.	
Single-phase or 3 phase supply voltage: 200/240 VAC				
LXM28AUA5M3X LXM28EUA5M3X LXM28SUA5M3X LXM28AU01M3X LXM28EU01M3X LXM28SU01M3X LXM28AU02M3X LXM28EU02M3X LXM28SU02M3X LXM28AU04M3X LXM28EU04M3X LXM28SU04M3X LXM28AU07M3X LXM28EU07M3X LXM28SU07M3X	Size 1	55 x 150 x 146	2.17 x 5.91 x 5.75	1.000 / 2.190
LXM28AU10M3X LXM28EU10M3X LXM28SU10M3X LXM28AU15M3X LXM28EU15M3X LXM28SU15M3X	Size 2	55 x 150 x 170	2.17 x 5.91 x 6.69	1.200 / 2.630
LXM28AU20M3X LXM28EU20M3X LXM28SU20M3X	Size 3	62 x 170 x 184	2.44 x 6.69 x 7.24	1.700 / 3.720
LXM28AU30M3X LXM28EU30M3X LXM28SU30M3X LXM28AU45M3X LXM28EU45M3X LXM28SU45M3X	Size 4	116 x 234 x 186	4.56 x 9.21 x 7.32	3.200 / 7.010

Lexium 28 & Motors

Lexium 28 servo drives

Connection accessories, accessories

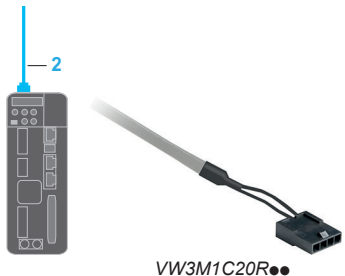
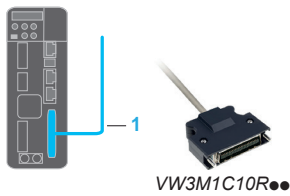
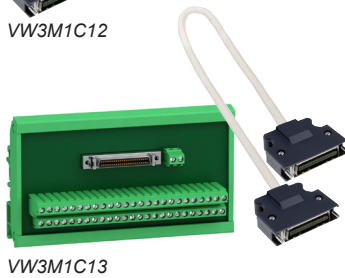

Servo drive with application name plate

Connection accessories

Cordsets					
Designation	Use for	Designation	Length m/ft	Unit reference	Weight kg/lb
Daisy chain connection of the DC-bus (sold in lots of 5)	Between two Lexium 28 servo drives	Equipped with 2 connectors	0.1 / 0.33	VW3M7101R01	0.150/ 0.220

Cable					
Designation	Use for	Designation	Length m/ft	Reference	Weight kg/lb
Shielded cable for Daisy chain connection of the DC-bus	Between two Lexium 28 servo drives	This cable can be used with DC-bus connector kit VW3M2207	15 / 49.21	VW3M7102R150	3.650/ 8.047

Connectors					
Designation	Use for	Designation	Unit reference	Weight kg/lb	
DC-bus connector kit	Lexium 28 servo drives	10 connectors for creating extension cordsets for the CN6 DC-bus interface	VW3M2207	0.050/ 0.110	

I/O connector	Lexium 28 servo drives	SUB-D 50-pin connector for CN1 I/O interface	VW3M1C12 (sold in lots of 3)	0.100/ 0.220
---------------	------------------------	--	--	-----------------

I/O terminal block module	Lexium 28 servo drives	Terminal block + Cordset Composed with 2x SUB-D 50-pin connectors type VW3M1C12, and one 0.5 m / 1.640 ft. cable, for CN1 I/O interface connection	VW3M1C13	0.380/ 0.838
---------------------------	------------------------	---	--------------------------	-----------------

Cordsets					
Designation	Use for	Designation	Length m/ft	Reference	Weight kg/lb
I/O PTI connection cordsets	Lexium 28 servo drives	Equipped with one SUB-D 50-pin connector for connection on CN1 interface (drive side), and open end (controller side) (item 1)	1 / 3.28	VW3M1C10R10	0.100/ 0.220
			2 / 6.56	VW3M1C10R20	0.200/ 0.441
			3 / 9.84	VW3M1C10R30	0.300/ 0.661

STO connection cordsets	Lexium 28 servo drives	Equipped with one Molex 4-pin connector for connection on CN9 interface (drive side), and open end (controller side) (item 2)	1 / 3.28	VW3M1C20R10	0.100/ 0.220
			2 / 6.56	VW3M1C20R20	0.200/ 0.441
			3 / 9.84	VW3M1C20R30	0.300/ 0.661

Accessory					
Designation	Use for	Designation	W x H mm/in.	Unit reference	Weight kg/lb
Application name plate	To be inserted onto a dedicated slot on the top of the Lexium 28 servo drives	It contains information about the servo drive	38.5 x 13 / 1.516 x 0.512	VW3M2501 (sold in lots of 50)	0.100/ 0.220



Configuration with the SoMove Setup software



TCSMCNAM3M002P

SoMove Setup software

Presentation

SoMove Setup software is used on Lexium 28 servo drives in just the same way as it is on other Schneider Electric drives and starters, to configure, adjust, debug, and maintain the drive.

The configuration of Lexium 28 servo drives can be done using the USB/RJ45 cordset TCSMCNAM3M002P (used between the PC and the Lexium 28, on CN3 interface).

SoMove Setup software can be downloaded from our web site www.se.com
More information: please consult the catalog Ref. DIA2ED2140801EN

References

Designation	Use for	Reference	Weight kg/lb
USB/RJ45 cordset Preassembled cordset with a USB connector (PC end), and an RJ45 connector (Device end) Length: 2.5 m (8.2 ft.)	Connecting a PC to the device (Lexium 28 servo drives)	TCSMCNAM3M002P	0.160/ 0.353

Multi-loader configuration tool

Presentation

The Multi-loader tool enables several configurations to be copied from a PC or a Lexium 28 servo drive and loaded onto another servo drive.
The Lexium 28 servo drives do not need to be powered up.



Configuration of a Lexium 28 in its packaging with the VW3A8121 Multi-loader tool + VW3A8126 cordset



VW3A8126

References

Designation	Equipped with	Reference	Weight kg/lb
Multi-loader configuration tool	<input type="checkbox"/> 1 cordset equipped with two RJ45 connectors <input type="checkbox"/> 1 cordset equipped with one type A USB connector and one mini B USB connector <input type="checkbox"/> 1 x 2 GB SD memory card <input type="checkbox"/> 1 x female/female RJ45 adapter <input type="checkbox"/> 4 AA 1.5 V LR6 round batteries	VW3A8121	0.910/ 2.006
Cordset for multi-loader tool For connecting the multi-loader tool to the Lexium 28 servo drive in its packaging	<input type="checkbox"/> A non-locking RJ45 connector with special mechanical catch on the drive end <input type="checkbox"/> An RJ45 connector on the Multi-loader end	VW3A8126	0.065/ 0.143

Options: braking resistors for servo drives

Presentation

Internal braking resistor

A braking resistor is built into the servo drive to absorb the braking energy. If the DC-bus voltage in the servo drive exceeds a specified value, this braking resistor is activated. The restored energy is converted into heat by the braking resistor. It enables maximum transient braking torque.

External braking resistor

When the servo motor has to be braked frequently, an external braking resistor is required to dissipate the excess braking energy. In this case, the internal braking resistor must be deactivated.

Several external braking resistors can be connected in parallel. The servo drive monitors the power dissipated in the braking resistor.

The casing degree of protection is IP65 for VW3A7601R●● to VW3A7607R●● braking resistors and IP20 for VW3A773● braking resistors.

The operating temperature around the unit can be between 0 and +50°C (+32 and +122°F).

To optimize the size of the braking resistor, the DC-buses on Lexium 28 servo drives in the same installation can be connected in parallel.

Applications:

Machines with high inertia, driving loads, and machines with fast cycles.

References

External braking resistor

Ohmic value Ω	Continuous power		Peak energy 230 V Ws	Length of connection cable		Reference	Weight kg/lb
	W	hp		m	ft		
10	1,100	1.47	–	–	–	VW3A7734	4.300/ 8.818
16	1,100	1.47	–	–	–	VW3A7733	3.800/ 6.613
27	100	0.13	3,800	0.75	2.46	VW3A7602R07	0.630/ 1.389
					2	6.56	VW3A7602R20
				3	9.84	VW3A7603R30	1.200/ 2.646
	200	0.26	7,400	0.75	2.46	VW3A7603R07	0.930/ 2.050
					2	6.56	VW3A7604R20
				3	9.84	VW3A7604R30	1.620/ 3.571
72	200	0.26	9,600	0.75	2.46	VW3A7606R07	0.930/ 2.050
					2	6.56	VW3A7606R20
				3	9.84	VW3A7606R30	1.200/ 2.646
	400	0.53	24,700	0.75	2.46	VW3A7607R07	1.420/ 3.131
					2	6.56	VW3A7607R20
				3	9.84	VW3A7607R30	1.620/ 3.571

Note: The total continuous power dissipated in the external braking resistor(s) must be less than or equal to the nominal power of the Lexium 28 servo drive.

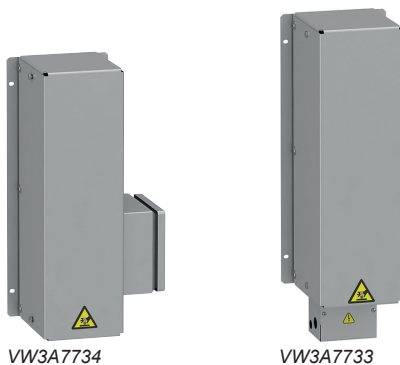

VW3A7734

VW3A7733

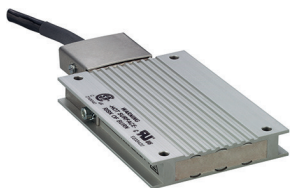

VW3A760●R●●

Lexium 28 & Motors

Lexium 28 servo drives

Communication on CANopen/CANmotion fieldbus with LXM28A●●● servo drives

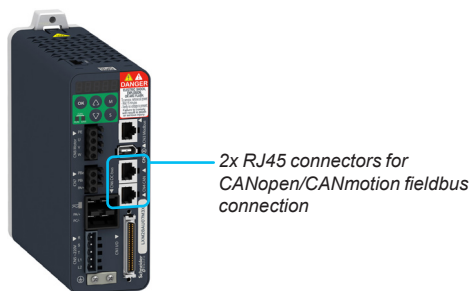

LXM28A●●●

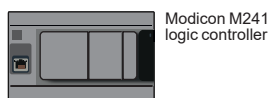

Modicon M241 logic controller

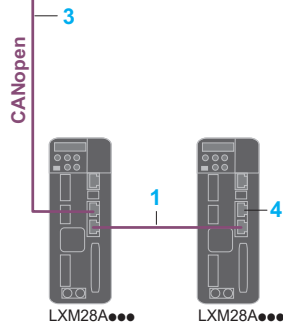

Modicon LMC058 motion controller

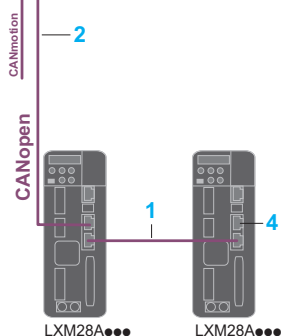

Modicon M251 logic controller

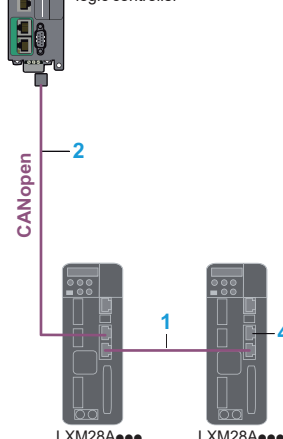

Examples of architectures with control by Modicon M241/M251 logic controllers or LMC058 motion controller

CANopen/CANmotion fieldbus for LXM28A●●● servo drives

Presentation

LXM28A●●● servo drives integrate the CANopen communication protocol as standard.

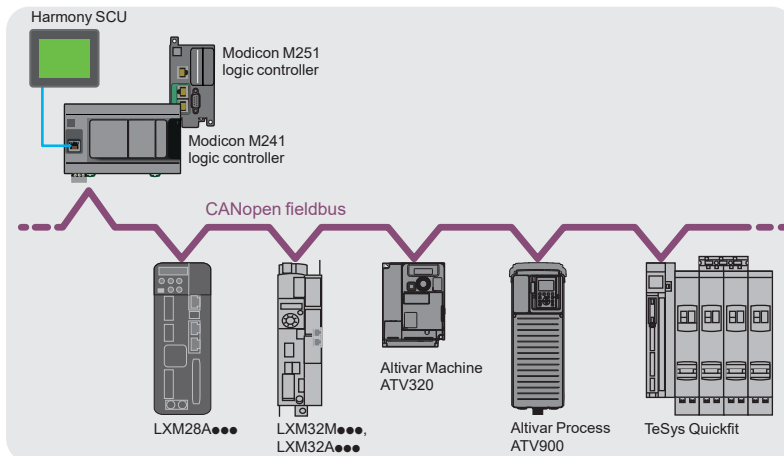

LXM28A●●● servo drives can be directly connected to CANopen/CANmotion fieldbus using the RJ45 connectors. The communication function provides access to the servo drive's configuration, adjustment, control, and monitoring functions. To simplify daisy chain connection, each servo drive is equipped with two RJ45 connectors (marked CN4 CAN).

Cordsets and cables (1)

Designation	Item no.	Length m (ft)	Reference	Weight kg/lb
CANopen cordsets (1) Equipped with 2 RJ45 connectors	1	0.3 (0.98)	VW3CANCARR03	0.320/ 0.705
		1 (3.28)	VW3CANCARR1	0.500/ 1.102
CANopen cordsets (1) Equipped with one 9-way female SUB-D connector with integrated line terminator and one RJ45 connector	2	1 (3.28)	VW3M3805R010	0.080/ 0.176
		3 (9.843)	VW3M3805R030	0.139/ 0.306
CANopen cables (1) Standard cables, C€ marking, Low smoke, zero halogen, Flame retardant (IEC 60332-1)	3	50 (164.04)	TSXCANCA50	4.930/ 10.869
		100 (328.08)	TSXCANCA100	8.800/ 19.401
		300 (984.25)	TSXCANCA300	24.560/ 54.145
CANopen cables (1) UL certification, C€ marking, Flame retardant (IEC 60332-2)	3	50 (164.04)	TSXCANCB50	3.580/ 7.893
		100 (328.08)	TSXCANCB100	7.840/ 17.284
		300 (984.25)	TSXCANCB300	21.870/ 48.215
CANopen cables (1) Cables for harsh environments (2) or mobile installation, C€ marking, Low smoke, zero halogen, Flame retardant (IEC 60332-1)	3	50 (164.04)	TSXCANCD50	3.510/ 7.738
		100 (328.08)	TSXCANCD100	7.770/ 17.130
		300 (984.25)	TSXCANCD300	21.700/ 47.840

Connection accessories (1)

Designation	Item no.	Use for	Reference	Weight kg/lb
CANopen line terminator for RJ45 connector 120 Ω	4	Lexium 28 servo drives	TCSCAR013M120	0.009/ 0.020

(1) For other CANopen fieldbus connection accessories, please consult our catalog Ref. [DIA3ED2160104EN](#)

(2) Harsh environment:

- Resistance to hydrocarbons, industrial oils, detergents, solder splashes
- Relative humidity up to 100%
- Saline atmosphere
- Significant temperature variations
- Operating temperature between - 10 °C/+ 14 °F and + 70 °C/+ 158 °F

Lexium 28 & Motors

Lexium 28 servo drives

Communication on EtherCAT fieldbus with LXM28E●●● servo drives



2x RJ45 connectors for EtherCAT fieldbus connection

LXM28E●●●

EtherCAT fieldbus for LXM28E●●● servo drives

Presentation

EtherCAT (EtherNet for Control Automation Technology) is an EtherNet-based open fieldbus system. This means that EtherNet technologies, such as embedded Web server, e-mail, and FTP transfer, can be used in the EtherCAT environment. The EtherCAT fieldbus is intended for applications requiring very short cycle times ($\leq 250 \mu\text{s}$) with low jitter ($\leq 1 \mu\text{s}$) for synchronization purposes

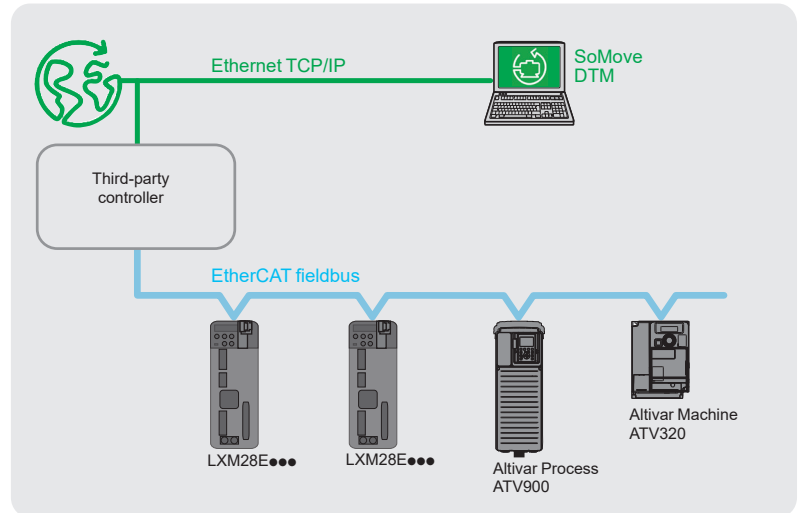

LXM28E●●● servo drives can be directly connected to EtherCAT fieldbus using the RJ45 connectors. The communication function provides access to the servo drive's configuration, adjustment, control, and monitoring functions.



490NTW000●●●
490NTC000●●●
490NTW000●●●U

Cordsets

Designation	Length m (ft)	Reference	Weight kg/lb
ConneXium cordsets: conforming to EIA/TIA-568, category 5, and IEC1180/EN50173, class D, standards			
Straight shielded twisted pair cordsets			
Preassembled cordsets with an RJ45 connector at each end	2 (6.56)	490NTW00002	—
	5 (16.40)	490NTW00005	—
	12 (39.37)	490NTW00012	—
	40 (131.23)	490NTW00040	—
	80 (262.467)	490NTW00080	—
Crossed shielded twisted pair cordsets			
Preassembled cordsets with an RJ45 connector at each end	5 (16.40)	490NTC00005	—
	15 (49.21)	490NTC00015	—
ConneXium cordsets: conforming to UL and CSA 22.1 standards			
Straight shielded twisted pair cordsets			
Preassembled cordsets with an RJ45 connector at each end	2 (6.56)	490NTW00002U	—
	5 (16.40)	490NTW00005U	—
	15 (49.21)	490NTW00012U	—
	40 (131.23)	490NTW00040U	—
	80 (262.47)	490NTW00080U	—



2x RJ45 connectors
for Sercos III fieldbus connection

LXM28S●●●

Sercos III fieldbus for LXM28S●●● servo drives

Presentation

Sercos is a globally standardized open digital interface for communication between industrial controllers, motion controllers, servo drives, IOs, variable speed drives, safety controller and safety IOs.

- Sercos III real-time hardware supports motion control (Sercos) and communication (Ethernet) functions.
- Sercos III is a standard that is compliant with the Ethernet standard (IEEE 802.3 and ISO/IEC 8802-3).

The system components for managing a machine are combined on a single Sercos Ethernet network.

The Sercos III bus can be wired in a line or ring topology.

LXM28S●●● servo drives integrate the Sercos communication protocol as standard.

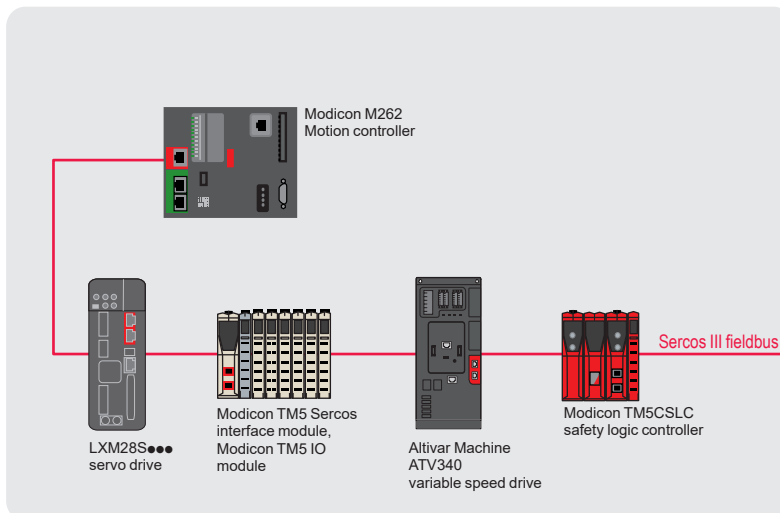

VW3E5001R●●●

Cordsets

Designation	For use	Length m/ft	Reference	Weight kg/lb
Sercos III cordsets for redundant ring Preassembled cordsets with an RJ45 connector at each end	Between Modicon M262 motion controller and LXM28S●●● servo drives	0.5/1.64	VW3E5001R005	0.040 0.088
		1/3.28	VW3E5001R010	0.060 0.132
		1.5/4.92	VW3E5001R015	0.080 0.176
		2/6.56	VW3E5001R020	0.100 0.220
		3/9.84	VW3E5001R030	0.140 0.308
		5/16.40	VW3E5001R050	0.220 0.485
		10/32.81	VW3E5001R100	0.420 0.925
		15/49.21	VW3E5001R150	0.620 1.366
		20/65.62	VW3E5001R200	0.820 1.807
		25/82.02	VW3E5001R250	1.020 2.248
30/98.42	VW3E5001R300	1.220 2.689		
40/131.23	VW3E5001R400	1.620 3.571		
50/164.04	VW3E5001R500	2.020 4.453		

Lexium 28 & Motors

Lexium 28 servo drives

Additional EMC input filters

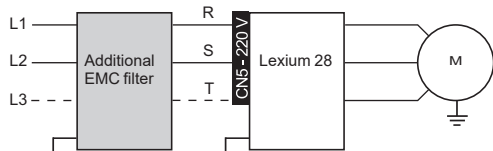

Lexium 28 servo drive with additional EMC filter



VW3A4420 EMC filter and Lexium 28 servo drive

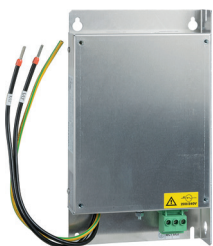

VW3A4421
VW3A4423

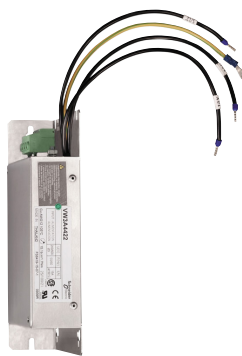

VW3A4422

Additional EMC input filters for servo drives

Presentation

Lexium 28 servo drives require external input filters to comply with the EMC standard for variable speed electrical power drive "products" IEC/EN 61800-3, edition 2, category C3 in environment 2, and to comply with the European directive on EMC (electromagnetic compatibility).

Applications

Additional EMC filters are mounted next to the device. They have tapped holes for mounting in an enclosure.

The maximum servo motor cable length conforming to IEC/EN 61800-3 category C3 (1) in environment 2 is 20 m (65.62 ft).

Use according to the type of line supply

Integrated or additional EMC filters can only be used on TN (neutral connection) or TT (neutral to ground) systems.

Lexium 28 servo drives cannot be used on IT (impedance grounded or isolated neutral) systems. Standard IEC/EN 61800-3, appendix D2.1, states that on IT systems, filters can cause permanent insulation monitors to operate in a random manner.

If a machine has to be installed on an IT system, an isolation transformer must be inserted in order to re-create a TT system on the secondary side.

References

Designation	Max. nominal power Combination	Line current (A)	Reference	Weight kg/lb
Single-phase supply voltage				
Additional EMC input filters for Lexium 28 servo drives	50 W to 750 W (0.067 to 1.00 hp) servo drives 1x EMC filter and a single Lexium 28 servo drive	9	VW3A4420	0.600/ 1.323
	1 kW and 1.5 kW (1.34 hp and 2.01 hp) servo drives 1x EMC filter and a single Lexium 28 servo drive	16	VW3A4421	0.775/ 1.709
Three-phase supply voltage				
Additional EMC input filters for Lexium 28 servo drives	50 W to 1.5 kW (0.067 hp to 2.01 hp), 2kW (2.68 hp), and 3kW (4.02 hp) servo drives 1x EMC filter and a single Lexium 28 servo drive	15	VW3A4422	0.900/ 1.984
	4.5 kW (6.03 hp) servo drives 1x EMC filter and a single Lexium 28 servo drive	25	VW3A4423	1.350/ 2.976

(1) Standard IEC/EN 61800-3: EMC immunity and conducted and radiated EMC emissions:
- Category C3 in environment 2: industrial premises.



Motor starters

Presentation

The combinations listed below can be used to create a complete motor starter unit comprising a circuit breaker, a contactor, and a Lexium 28 servo drive.

- GV2P circuit-breaker provides protection against accidental short-circuits, disconnection and, if necessary, isolation.
- LC1 contactor turns on and manages any safety functions, as well as isolating the servo motor on stopping.
- Lexium 28 servo drive controls the servo motor, provides protection against short-circuits between the servo drive and the servo motor, and protects the motor cable against overloads. Overload protection is provided by the servo drive's motor thermal protection.

Combinations

Servo drive Reference	Nominal power		Mains number of phases	Circuit-breaker (1)		Contactor
	kW	hp		Reference	Rating A	Reference (2) (3)
Mains supply voltage: 200...240 VAC 50/60Hz						
LXM28AUA5M3X, LXM28EUA5M3X, LXM28SUA5M3X	0.05	0.067	1 or 3 phases	GV2P14	10	LC1K0610●●
LXM28AU01M3X, LXM28EU01M3X, LXM28SU01M3X	0.1	0.13	1 or 3 phases	GV2P14	10	LC1K0610●●
LXM28AU02M3X, LXM28EU02M3X, LXM28SU02M3X	0.2	0.26	1 or 3 phases	GV2P14	10	LC1K0610●●
LXM28AU04M3X, LXM28EU04M3X, LXM28SU04M3X	0.4	0.53	1 or 3 phases	GV2P14	10	LC1K09●●
LXM28AU07M3X, LXM28EU07M3X, LXM28SU07M3X	0.75	1.00	1 or 3 phases	GV2P14	10	LC1K09●●
LXM28AU10M3X, LXM28EU10M3X, LXM28SU10M3X	1	1.34	1 or 3 phases	GV2P14	10	LC1K12●●
LXM28AU15M3X, LXM28EU15M3X, LXM28SU15M3X	1.5	2.01	1 or 3 phases	GV2P16	14	LC1D18●●
LXM28AU20M3X, LXM28EU20M3X, LXM28SU20M3X	2	2.68	3 phases	GV2P20	18	LC1D32●●
LXM28AU30M3X, LXM28EU30M3X, LXM28SU30M3X	3	4.02	3 phases	GV2P20	18	LC1D32●●
LXM28AU45M3X, LXM28EU45M3X, LXM28SU45M3X	4.5	6.03	3 phases	GV2P21	23	LC1D65●●

(1) Circuit-breakers for single drive installation according to IEC 60364-5-52

(2) Composition of the contactors:

LC1 K06: 3 poles + 1 N/O auxiliary contact

LC1 D●●: 3 poles + 1 N/O auxiliary contact + 1 N/C auxiliary contact

(3) Replace ●● with the control circuit voltage reference given in the table below:

LC1K	Volts ~	220	230	240
	50/60 Hz	M7	P7	U7
LC1D	Volts ~	220/230	230	230/240
	50 Hz	M5	P5	U5
	60 Hz	M6	-	U6
	50/60 Hz	M7	P7	U7

For other available voltages between 24 V and 660 V, or a DC control circuit, please contact our Customer Care Centre.

Protection using class J fuses (UL certification)

Servo drive Reference	Nominal power		Fuse to be placed upstream
	kW	hp	A
Mains supply voltage: 200...240 VAC 50/60Hz			
LXM28AUA5M3X, LXM28EUA5M3X, LXM28SUA5M3X	0.05	0.067	5
LXM28AU01M3X, LXM28EU01M3X, LXM28SU01M3X	0.1	0.13	5
LXM28AU02M3X, LXM28EU02M3X, LXM28SU02M3X	0.2	0.26	5
LXM28AU04M3X, LXM28EU04M3X, LXM28SU04M3X	0.4	0.53	20
LXM28AU07M3X, LXM28EU07M3X, LXM28SU07M3X	0.75	1.00	20
LXM28AU10M3X, LXM28EU10M3X, LXM28SU10M3X	1	1.34	25
LXM28AU15M3X, LXM28EU15M3X, LXM28SU15M3X	1.5	2.01	40
LXM28AU20M3X, LXM28EU20M3X, LXM28SU20M3X	2	2.68	60
LXM28AU30M3X, LXM28EU30M3X, LXM28SU30M3X	3	4.02	80
LXM28AU45M3X, LXM28EU45M3X, LXM28SU45M3X	4.5	6.03	160

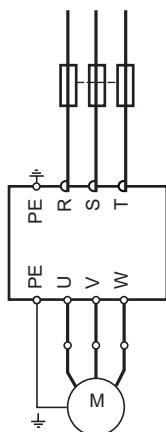

Lexium 28 servo drive + BCH2 servo motor with fuse protection



BCH2 with free leads connection



BCH2 servo motor with MIL connectors

BCH2 servo motors

Presentation

BCH2 motors are synchronous AC servo motors, designed for high performance applications such as material working, machine tools, etc

- BCH2 motors are available in six flange sizes: 40 mm (1.58 in.), 60 mm (2.36 in.), 80 mm (3.15 in.), 100 mm (3.94 in.), 130 mm (5.12 in.), and 180 mm (7.08 in.).
- Depending on flange size, the BCH2 motors are supplied with:
 - free leads with connectors
 - or MIL connectors
- With the three available types of motor inertia, ranging from low to high inertia, the servo motors can be used in a very wide variety of installations:
 - low inertia: power between 0.2 kW and 1 kW (0.26 hp and 1.34 hp), suitable for textile and packaging applications.
 - medium inertia: power between 0.05 kW and 7,5 kW (0,067 hp and 10,06 hp), suitable for material working and machine tool applications.
 - high inertia: 0.75 kW (1.00 hp) power, suitable for metal working and printing applications.
- BCH2 motors are available with holding brake, and equipped as standard with a high-resolution (20-bit) single-turn absolute encoder.

Examples of applications according to motor inertia type:

Type of machine	Inertia		
	Low	Medium	High
Conveyors		✓	✓
Packaging machines	✓	✓	
Printers		✓	✓
Loaders/unloaders			✓
Presses			✓
PCB drilling machines	✓		
Electronic card testers	✓		
Labelling machines	✓		
Knitting and embroidery machines		✓	✓
Special machines		✓	✓
Winders/unwinders		✓	

Holding brake

BCH2 servo motors can be equipped with an electromagnetic holding brake.

Recommendation: Do not use the holding brake as a dynamic brake for deceleration, as this will quickly damage the brake.

Integrated encoder

BCH2 servo motors are equipped with a 20-bit single-turn absolute encoder.

- measuring the motor angular position with a precision of ± 2.6 arc minutes so that flows can be synchronized
- measuring the servo motor speed via the associated Lexium 28 servo drive (this information is used by the servo drive's position and speed controller)
- sending data from the servo motor to the servo drive, providing automatic identification of the motor when the servo drive starts.

Description

BCH2 servo motors, with a 3-phase stator and a rotor with rare earth based permanent magnets, consist of:

- 1 Connector for the power cable
- 2 Connector for the encoder cable
- 3 Casing with RAL 9005 opaque black paint coating
- 4 Smooth or keyed shaft end (depending on the model)
- 5 4-point axial mounting flange (Flange is mechanically compatible for mounting with Asian style servo motors).

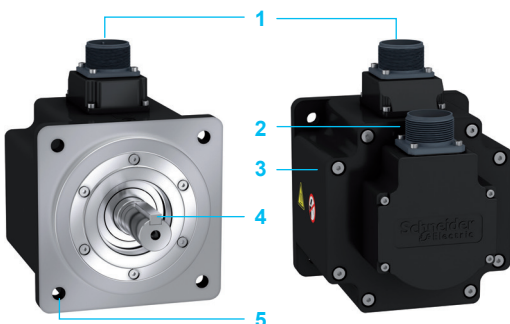

Lexium 28 & Motors

BCH2 servo motors

BCH2 servo motors														
To order a BCH2 servo motor, make up the reference as follows:														
Brushless servo motor	B	C	H	2	•	•	••	•	•	•	•	•	C	
Inertia	Low inertia				L									
	Medium inertia				M									
	High inertia				H									
Flange size	40 mm (1.58 in.)				B									
	60 mm (2.36 in.)				D									
	80 mm (3.15 in.)				F									
	100 mm (3.94 in.)				H									
	130 mm (5.12 in.)				M									
	180 mm (7.08 in.)				R									
Rated output	50 W (0.067 hp)				A5									
	100 W (0.13 hp)				01									
	200 W (0.26 hp)				02									
	300 W (0.41 hp)				03									
	400 W (0.53 hp)				04									
	500 W (0.67 hp)				05									
	600 W (0.80 hp)				06									
	750 W (1.00 hp)				07									
	850 W (1.13 hp)				08									
	1 kW (1.34 hp)				10									
	1.5 kW (2.01 hp)				15									
	2 kW (2.68 hp)				20									
	3 kW (4.02 hp)				30									
	3.5 kW (4.69 hp)				35									
4.5 kW (6.03 hp)				45										
Nominal speed	1000/1500 rpm				1									
	2000 rpm				2									
	3000 rpm				3									
Shaft end	Smooth shaft (shaft IP 54; housing IP 65) (1)				0									
	Keyed shaft (shaft IP 54; housing IP 65) (1)				1									
	Smooth shaft (shaft & housing IP 65)				2									
	Keyed shaft (shaft & housing IP 65)				3									
Encoder	High resolution single-turn absolute encoder, 20-bit resolution				C									
Holding brake	Without brake				A									
	With brake (option)				F									
Connections	Free leads with connectors (BCH2•B/•D/•F motors only)				5									
	MIL connectors (BCH2•H/•M/•R motors only)				6									
Mechanical motor design	Motor compatible with Asian style mounting standards												C	

Connection components for BCH2 motors

Cables and connectors to be ordered separately, for connection to Lexium 28 servo drives. Schneider Electric has taken particular care over the compatibility of BCH2 servo motors and Lexium 28 servo drives. See [pages 22 and 23](#)

BCH2 servo motors											
Dimensions and weight											
Servo motor	Pn	Flange		Dimensions (overall)				Weight			
				Servo motor without brake		Servo motor with brake		without brake		with brake	
				Width x Height x Depth (W x H x D)				Width x Height x Depth (W x H x D)			
W	mm	in.	mm	in.	mm	in.	kg	lb	kg	lb	
BCH2MBA53●●●5C	50	40	1.57	40 x 58.5 x 82	1.57 x 2.30 x 3.23	40 x 58.5 x 112	1.57 x 2.30 x 4.41	0.400	0.88	0.600	1.32
BCH2MB013●●●5C	100	40	1.57	40 x 58.5 x 100	1.57 x 2.30 x 3.94	40 x 58.5 x 130	1.57 x 2.30 x 5.12	0.560	1.23	0.770	1.70
BCH2LD023●●●5C	200	60	2.36	60 x 78.5 x 104	2.36 x 3.09 x 4.09	60 x 78.5 x 140	2.36 x 3.09 x 5.51	1.020	2.25	1.500	3.31
BCH2LD043●●●5C	400	60	2.36	60 x 78.5 x 129	2.36 x 3.09 x 5.08	60 x 78.5 x 165	2.36 x 3.09 x 6.50	1.450	3.20	2.000	4.41
BCH2LF043●●●5C	400	80	3.15	80 x 98.5 x 112	3.15 x 3.88 x 4.41	80 x 98.5 x 152	3.15 x 3.88 x 4.41	2.000	4.41	2.800	6.17
BCH2HF073●●●5C	750	80	3.15	80 x 98.5 x 138	3.15 x 3.88 x 5.43	80 x 98.5 x 178	3.15 x 3.88 x 7.01	2.900	6.39	3.700	8.16
BCH2LF073●●●5C	750	80	3.15	80 x 98.5 x 138	3.15 x 3.88 x 5.43	80 x 98.5 x 178	3.15 x 3.88 x 7.01	2.800	6.17	3.600	7.94
BCH2LH103●●●6C	1000	100	3.94	100 x 145.6 x 153.5	3.94 x 5.73 x 6.04	100 x 145.6 x 180.5	3.94 x 5.73 x 7.11	4.600	10.14	5.100	11.24
BCH2LH203●●●6C	2000	100	3.94	100 x 145.6 x 198.5	3.94 x 5.73 x 7.81	100 x 145.6 x 225.5	3.94 x 5.73 x 8.88	6.700	14.77	7.200	15.87
BCH2MM031●●●6C	300	130	5.12	130 x 176 x 147	5.12 x 6.92 x 5.79	130 x 176 x 183	5.12 x 6.92 x 7.20	7.000	15.43	8.200	18.08
BCH2MM052●●●6C	500	130	5.12	130 x 176 x 147	5.12 x 6.92 x 5.79	130 x 176 x 183	5.12 x 6.92 x 7.20	7.000	15.43	8.200	18.08
BCH2MM061●●●6C	600	130	5.12	130 x 176 x 147	5.12 x 6.92 x 5.79	130 x 176 x 183	5.12 x 6.92 x 7.20	7.000	15.43	8.200	18.08
BCH2MM081●●●6C	850	130	5.12	130 x 176 x 187	5.12 x 6.92 x 7.36	130 x 176 x 216	5.12 x 6.92 x 8.50	9.600	21.16	10.900	24.03
BCH2MM091●●●6C	900	130	5.12	130 x 176 x 163	5.12 x 6.92 x 6.42	130 x 176 x 198	5.12 x 6.92 x 7.80	7.600	16.76	8.800	19.40
BCH2MM102●●●6C	1000	130	5.12	130 x 176 x 147	5.12 x 6.92 x 5.79	130 x 176 x 183	5.12 x 6.92 x 7.20	7.000	15.43	8.200	18.08
BCH2HM102●●●6C	1000	130	5.12	130 x 176 x 147	5.12 x 6.92 x 5.79	130 x 176 x 176	5.12 x 6.92 x 6.92	7.000	15.43	8.200	18.08
BCH2MM152●●●6C	1500	130	5.12	130 x 176 x 167	5.12 x 6.92 x 6.57	130 x 176 x 202	5.12 x 6.92 x 7.95	7.600	16.76	8.800	19.40
BCH2MM202●●●6C	2000	130	5.12	130 x 176 x 187	5.12 x 6.92 x 7.36	130 x 176 x 216	5.12 x 6.92 x 8.50	9.700	21.38	11.000	24.25
BCH2MR202●●●6C	2000	180	7.09	180 x 245 x 169	7.09 x 9.65 x 6.65	180 x 245 x 203	7.09 x 9.65 x 7.99	13.000	28.66	18.000	39.68
BCH2HR202●●●6C	2000	180	7.09	180 x 245 x 168	7.09 x 9.65 x 6.61	180 x 245 x 203	7.09 x 9.65 x 7.99	13.000	28.66	18.000	39.68
BCH2MR301●●●6C	3000	180	7.09	180 x 245 x 202	7.09 x 9.65 x 7.95	180 x 245 x 235	7.09 x 9.65 x 9.25	18.500	40.79	23.000	50.71
BCH2MR302●●●6C	3000	180	7.09	180 x 245 x 202	7.09 x 9.65 x 7.95	180 x 245 x 235	7.09 x 9.65 x 9.25	18.500	40.79	23.000	50.71
BCH2MR352●●●6C	3500	180	7.09	180 x 245 x 202	7.09 x 9.65 x 7.95	180 x 245 x 235	7.09 x 9.65 x 9.25	18.500	40.79	23.000	50.71
BCH2MR451●●●6C	4500	180	7.09	180 x 245 x 235	7.09 x 9.65 x 9.25	180 x 245 x 279	7.09 x 9.65 x 10.98	23.640	52.12	28.000	61.73

●●●: Please refer to the type code table on page 19

Lexium 28 & Motors

BCH2 servo motors

Options: holding brake, integrated encoder, GBX planetary gearboxes

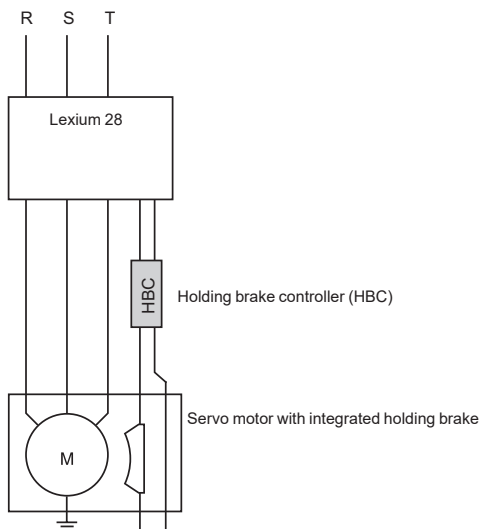

VW3M3103

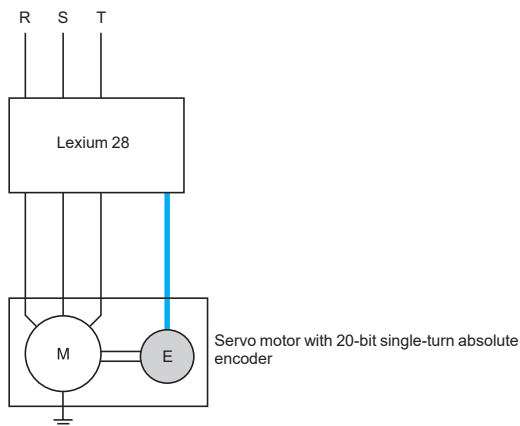

[DIA3ED2160313EN](#)

Holding brake

Presentation

If a servo motor has a holding brake, it is necessary to give an appropriate control logic (HBC, Holding Brake Controller), which releases the brake when power is supplied to the servo motor and immobilizes the servo motor shaft when it is stationary. The holding brake controller amplifies the braking control signal (Digital output) transmitted by the Lexium 28 servo drive, so that the brake is deactivated quickly. It then reduces this control signal so as to decrease the power dissipated by the holding brake.

References

Designation	Designation	Reference	Weight kg/lb
Holding brake controller	<input type="checkbox"/> 24 V $\overline{\text{AC}}$ power supply	VW3M3103	0.600/ 1.323
	<input type="checkbox"/> Max. power 50 W (0.06 hp)		
	<input type="checkbox"/> IP20		
	<input type="checkbox"/> for mounting on 55 mm (2.17 in) \perp rail		

Integrated encoder in BCH2 servo motors

Presentation

The standard measurement device is a 20-bit single-turn absolute encoder integrated in BCH2 servo motors. This measurement device is particularly suited to the Lexium 28 range of servo drives.

Use of this interface enables:

- Automatic identification of BCH2 servo motor data by the servo drive
- Automatic initialization of the servo drive control loops, thus simplifying installation and drive commissioning at the machine

GBX planetary gearboxes

Please refer to the catalog Ref. [DIA3ED2160313EN](#)

Lexium 28 & Motors

BCH2 servo motors

Connection components

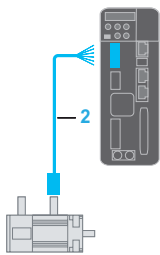
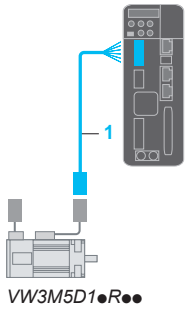

VW3M5D2●R●●
VW3M5D4●R●●
VW3M5D6●R●●

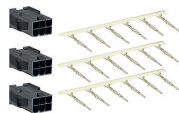
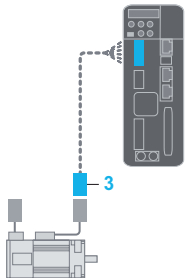

VW3M5D●●

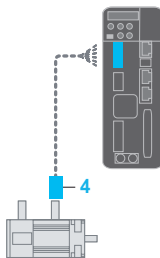

Connection components for BCH2 servo motors

Designation	AWG	mm ² (in ²)	Length m/ft	Reference	Weight kg/lb
-------------	-----	---------------------------------------	----------------	-----------	-----------------

Shielded power cordsets for BCH2 motors without brake

Shielded power cordsets Equipped with one quick connector (servo motor side), and open end (servo drive side) (item 1)	AWG18	4x 0.82...1.0 (4x 0.001... 0.001)	1.5 / 4.92	VW3M5D1AR15	0.200/ 0.441
			3 / 9.84	VW3M5D1AR30	0.300/ 0.661
			5 / 16.40	VW3M5D1AR50	0.450/ 0.992

Shielded power cordsets Equipped with one MIL connector (servo motor side), and open end (servo drive side) (item 2)	AWG16	4x 1.3...1.5 (4x 0.0020... 0.0023)	3 / 9.84	VW3M5D2AR30	0.450/ 0.992
			5 / 16.40	VW3M5D2AR50	0.700/ 1.543

AWG12	4x 3.3...4.0 (4x 0.0051... 0.0062)	3 / 9.84	VW3M5D4AR30	0.750/ 1.653
		5 / 16.40	VW3M5D4AR50	1.250/ 2.756

AWG10	4x 6.0 (4x 0.0093)	3 / 9.84	VW3M5D6AR30	2.100/ 4.630
		5 / 16.40	VW3M5D6AR50	3.400/ 7.496

Shielded power cordsets for BCH2 motors with brake

Shielded power cordsets Equipped with one quick connector (servo motor side), and open end (servo drive side) (item 1)	AWG18	6x 0.82...1.0 (6x 0.001... 0.001)	3 / 9.84	VW3M5D1FR30	0.300/ 0.661
			5 / 16.40	VW3M5D1FR50	0.450/ 0.992

Shielded power cordsets Equipped with one MIL connector (servo motor side), and a free lead (servo drive side) (item 2)	AWG16	6x 1.3...1.5 (6x 0.0020... 0.0023)	3 / 9.84	VW3M5D2FR30	0.650/ 1.433
			5 / 16.40	VW3M5D2FR50	0.900/ 1.984

AWG12	6x 3.3...4.0 (6x 0.0051... 0.0062)	3 / 9.84	VW3M5D4FR30	0.950/ 2.094
		5 / 16.40	VW3M5D4FR50	1.450/ 3.197

AWG10	4x 6.0 (4x 0.0093)	3 / 9.84	VW3M5D6FR30	3.000/ 6.614
		5 / 16.40	VW3M5D6FR50	5.000/ 11.023

Motor power connectors kits

Designation	Use for	Unit reference	Weight kg/lb
-------------	---------	----------------	-----------------

Motor power connector kits (sold in lots of 3) (item 3)	BCH2●B/●D/●F motors, flange size: 40/60/80 mm (1.58/2.36/3.15 in.), with free leads connection, without brake	VW3M5D1A	0.150/ 0.331
--	---	----------	-----------------

BCH2●B/●D/●F motors, flange size: 40/60/80 mm (1.58/2.36/3.15 in.), with free leads connection, with brake	VW3M5D1F	0.150/ 0.331
--	----------	-----------------

Motor power MIL connector kits (item 4)	BCH2●H/●M motors, flange size: 100/130 mm (3.94/5.12 in.), with or without brake	VW3M5D2A	0.300/ 0.661
---	--	----------	-----------------

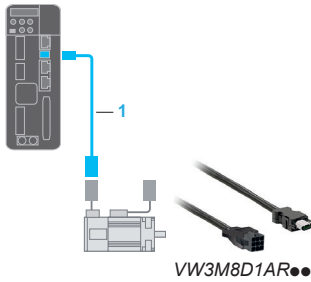

VW3M8D1AR●●

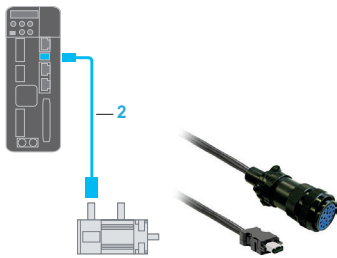

VW3M8D2AR●●

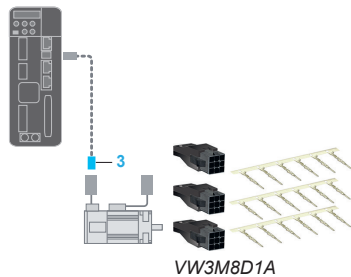

VW3M8D1A

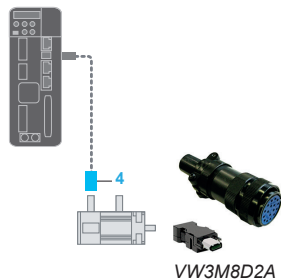

VW3M8D2A

Connection components for BCH2 servo motors

Designation	Use for	Composition	Length m/ft	Reference	Weight kg/lb
Shielded encoder cordsets					
Shielded encoder cordsets Equipped with a connector at both ends (item 1)	BCH2●B/●D/●F motors, for connection on CN2 interface	10x 0.13 mm ²	1.5 / 4.92	VW3M8D1AR15	0.500/ 1.102
			3 / 9.84	VW3M8D1AR30	1.000/ 2.205
			5 / 16.40	VW3M8D1AR50	1.200/ 2.646
Shielded encoder cordsets Equipped with one MIL connector (servo motor side), and a firewire connector (servo drive side) (item 2)	BCH2●H/●M/●R, for connection on CN2 interface	10x 0.13 mm ²	3 / 9.84	VW3M8D2AR30	1.300/ 2.866
			5 / 16.40	VW3M8D2AR50	1.500/ 3.307
Encoder connector kits					
Encoder connector kits	BCH2●B/●D/●F motors (flange: 40/60/80 mm) with free leads connection (item 3) (sold in lots of 3)			VW3M8D1A	0.150/ 0.331
				VW3M8D2A	0.150/ 0.331
		BCH2●H/●M/●R motors (flange: 100/130/180 mm) with MIL connector (item 4) (sold in lots of 1)		VW3M8D2A	0.150/ 0.331

Selection of motor connector kit, or encoder connector kit, according to BCH2 motor type

Motor	Motor power cable connector kit		Encoder connector kit	Motor power cable		Encoder cable
	Without brake	With brake		Without brake	With brake	
BCH2MBA53●●●5C						
BCH2MB013●●●5C						
BCH2LD023●●●5C						
BCH2LD043●●●5C	VW3M5D1A	VW3M5D1F	VW3M8D1A	VW3M5D1AR15 VW3M5D1AR30 VW3M5D1AR50	VW3M5D1FR30 VW3M5D1FR50	VW3M8D1AR15 VW3M8D1AR30 VW3M8D1AR50
BCH2LF043●●●5C						
BCH2HF073●●●5C						
BCH2LF073●●●5C						
BCH2LH103●●●6C						
BCH2LH203●●●6C						
BCH2MM081●●●6C						
BCH2MM031●●●6C						
BCH2MM052●●●6C						
BCH2MM061●●●6C	VW3M5D2A	VW3M5D2A		VW3M5D2AR30 VW3M5D2AR50	VW3M5D2FR30 VW3M5D2FR50	
BCH2MM102●●●6C						
BCH2HM102●●●6C			VW3M8D2A			VW3M8D2AR30 VW3M8D2AR50
BCH2MM091●●●6C						
BCH2MM152●●●6C						
BCH2MM202●●●6C						
BCH2MR202●●●6C				VW3M5D4AR30 VW3M5D4AR50	VW3M5D4FR30 VW3M5D4FR50	
BCH2HR202●●●6C						
BCH2MR301●●●6C						
BCH2MR302●●●6C	VW3M5D2B	VW3M5D2B				
BCH2MR302●●●6C				VW3M5D6AR30 VW3M5D6AR50	VW3M5D6FR30 VW3M5D6FR50	
BCH2MR352●●●6C						
BCH2MR451●●●6C						

●●●: Please refer to the type code table on page 19

Lexium 28 & Motors

Lexium 28 servo drives and BCH2 servo motors

Product reference index

#	BCH2LD0432CF5C	19	BCH2MB0132CF5C	19	BCH2MM0812CF6C	19	BCH2MR2022CF6C	19	
490NTC00005	14	BCH2LD0432MA5C	19	BCH2MB0132MA5C	19	BCH2MM0812MA6C	19	BCH2MR2022MA6C	19
490NTC00015	14	BCH2LD0432MF5C	19	BCH2MB0132MF5C	19	BCH2MM0812MF6C	19	BCH2MR2022MF6C	19
490NTW00002	14	BCH2LD0433CA5C	19	BCH2MB0133CA5C	19	BCH2MM0813CA6C	19	BCH2MR2023CA6C	19
490NTW00002U	14	BCH2LD0433CF5C	19	BCH2MB0133CF5C	19	BCH2MM0813CF6C	19	BCH2MR2023CF6C	19
490NTW00005	14	BCH2LD0433MA5C	19	BCH2MB0133MA5C	19	BCH2MM0813MA6C	19	BCH2MR2023MA6C	19
490NTW00005U	14	BCH2LD0433MF5C	19	BCH2MB0133MF5C	19	BCH2MM0813MF6C	19	BCH2MR2023MF6C	19
490NTW00012	14	BCH2LF0430CA5C	19	BCH2MBA530CA5C	19	BCH2MM0910CA6C	19	BCH2MR3010CA6C	19
490NTW00012U	14	BCH2LF0430CF5C	19	BCH2MBA530CF5C	19	BCH2MM0910CF6C	19	BCH2MR3010CF6C	19
490NTW00040	14	BCH2LF0431CA5C	19	BCH2MBA531CA5C	19	BCH2MM0911CA6C	19	BCH2MR3011CA6C	19
490NTW00040U	14	BCH2LF0431CF5C	19	BCH2MBA531CF5C	19	BCH2MM0911CF6C	19	BCH2MR3011CF6C	19
490NTW00080	14	BCH2LF0432CA5C	19	BCH2MBA532CA5C	19	BCH2MM0912CA6C	19	BCH2MR3012CA6C	19
490NTW00080U	14	BCH2LF0432CF5C	19	BCH2MBA532CF5C	19	BCH2MM0912CF6C	19	BCH2MR3012CF6C	19
B		BCH2LF0432MA5C	19	BCH2MBA532MA5C	19	BCH2MM0912MA6C	19	BCH2MR3012MA6C	19
BCH2HF0730CA5C	19	BCH2LF0432MF5C	19	BCH2MBA532MF5C	19	BCH2MM0912MF6C	19	BCH2MR3012MF6C	19
BCH2HF0730CF5C	19	BCH2LF0433CA5C	19	BCH2MBA533CA5C	19	BCH2MM0913CA6C	19	BCH2MR3013CA6C	19
BCH2HF0731CA5C	19	BCH2LF0433CF5C	19	BCH2MBA533CF5C	19	BCH2MM0913CF6C	19	BCH2MR3013CF6C	19
BCH2HF0731CF5C	19	BCH2LF0433MA5C	19	BCH2MBA533MA5C	19	BCH2MM0913MA6C	19	BCH2MR3013MA6C	19
BCH2HF0732CA5C	19	BCH2LF0433MF5C	19	BCH2MBA533MF5C	19	BCH2MM0913MF6C	19	BCH2MR3013MF6C	19
BCH2HF0732CF5C	19	BCH2LF0730CA5C	19	BCH2MM0310CA6C	19	BCH2MM1020CA6C	19	BCH2MR3020CA6C	19
BCH2HF0732MA5C	19	BCH2LF0730CF5C	19	BCH2MM0310CF6C	19	BCH2MM1020CF6C	19	BCH2MR3020CF6C	19
BCH2HF0732MF5C	19	BCH2LF0731CA5C	19	BCH2MM0311CA6C	19	BCH2MM1021CA6C	19	BCH2MR3021CA6C	19
BCH2HF0733CA5C	19	BCH2LF0731CF5C	19	BCH2MM0311CF6C	19	BCH2MM1021CF6C	19	BCH2MR3021CF6C	19
BCH2HF0733CF5C	19	BCH2LF0732CA5C	19	BCH2MM0312CA6C	19	BCH2MM1022CA6C	19	BCH2MR3022CA6C	19
BCH2HF0733MA5C	19	BCH2LF0732CF5C	19	BCH2MM0312CF6C	19	BCH2MM1022CF6C	19	BCH2MR3022CF6C	19
BCH2HF0733MF5C	19	BCH2LF0732MA5C	19	BCH2MM0312MA6C	19	BCH2MM1022MA6C	19	BCH2MR3022MA6C	19
BCH2HF0830CA5C	19	BCH2LF0732MF5C	19	BCH2MM0312MF6C	19	BCH2MM1022MF6C	19	BCH2MR3022MF6C	19
BCH2HM1022CA6C	19	BCH2LF0733CA5C	19	BCH2MM0313CA6C	19	BCH2MM1023CA6C	19	BCH2MR3023CA6C	19
BCH2HM1022CF6C	19	BCH2LF0733CF5C	19	BCH2MM0313CF6C	19	BCH2MM1023CF6C	19	BCH2MR3023CF6C	19
BCH2HM1022MA6C	19	BCH2LF0733MA5C	19	BCH2MM0313MA6C	19	BCH2MM1023MA6C	19	BCH2MR3023MA6C	19
BCH2HM1022MF6C	19	BCH2LF0733MF5C	19	BCH2MM0313MF6C	19	BCH2MM1023MF6C	19	BCH2MR3023MF6C	19
BCH2HM1023CA6C	19	BCH2LH1030CA6C	19	BCH2MM0520CA6C	19	BCH2MM1520CA6C	19	BCH2MR3520CA6C	19
BCH2HM1023CF6C	19	BCH2LH1030CF6C	19	BCH2MM0520CF6C	19	BCH2MM1520CF6C	19	BCH2MR3520CF6C	19
BCH2HM1023MA6C	19	BCH2LH1031CA6C	19	BCH2MM0521CA6C	19	BCH2MM1521CA6C	19	BCH2MR3521CA6C	19
BCH2HM1023MF6C	19	BCH2LH1031CF6C	19	BCH2MM0521CF6C	19	BCH2MM1521CF6C	19	BCH2MR3521CF6C	19
BCH2HR2022CA6C	19	BCH2LH1032CA6C	19	BCH2MM0522CA6C	19	BCH2MM1522CA6C	19	BCH2MR3522CA6C	19
BCH2HR2022CF6C	19	BCH2LH1032CF6C	19	BCH2MM0522CF6C	19	BCH2MM1522CF6C	19	BCH2MR3522CF6C	19
BCH2HR2022MA6C	19	BCH2LH1032MA6C	19	BCH2MM0522MA6C	19	BCH2MM1522MA6C	19	BCH2MR3522MA6C	19
BCH2HR2022MF6C	19	BCH2LH1032MF6C	19	BCH2MM0522MF6C	19	BCH2MM1522MF6C	19	BCH2MR3522MF6C	19
BCH2HR2023CA6C	19	BCH2LH1033CA6C	19	BCH2MM0523CA6C	19	BCH2MM1523CA6C	19	BCH2MR3523CA6C	19
BCH2HR2023CF6C	19	BCH2LH1033CF6C	19	BCH2MM0523CF6C	19	BCH2MM1523CF6C	19	BCH2MR3523CF6C	19
BCH2HR2023MA6C	19	BCH2LH1033MA6C	19	BCH2MM0523MA6C	19	BCH2MM1523MA6C	19	BCH2MR3523MA6C	19
BCH2HR2023MF6C	19	BCH2LH1033MF6C	19	BCH2MM0523MF6C	19	BCH2MM1523MF6C	19	BCH2MR3523MF6C	19
BCH2LD0230CA5C	19	BCH2LH2030CA6C	19	BCH2MM0610CA6C	19	BCH2MM2020CA6C	19	BCH2MR4510CA6C	19
BCH2LD0230CF5C	19	BCH2LH2030CF6C	19	BCH2MM0610CF6C	19	BCH2MM2020CF6C	19	BCH2MR4510CF6C	19
BCH2LD0231CA5C	19	BCH2LH2031CA6C	19	BCH2MM0611CA6C	19	BCH2MM2021CA6C	19	BCH2MR4511CA6C	19
BCH2LD0231CF5C	19	BCH2LH2031CF6C	19	BCH2MM0611CF6C	19	BCH2MM2021CF6C	19	BCH2MR4511CF6C	19
BCH2LD0232CA5C	19	BCH2LH2032CA6C	19	BCH2MM0612CA6C	19	BCH2MM2022CA6C	19	BCH2MR4512CA6C	19
BCH2LD0232CF5C	19	BCH2LH2032CF6C	19	BCH2MM0612CF6C	19	BCH2MM2022CF6C	19	BCH2MR4512CF6C	19
BCH2LD0232MA5C	19	BCH2LH2032MA6C	19	BCH2MM0612MA6C	19	BCH2MM2022MA6C	19	BCH2MR4512MA6C	19
BCH2LD0232MF5C	19	BCH2LH2032MF6C	19	BCH2MM0612MF6C	19	BCH2MM2022MF6C	19	BCH2MR4512MF6C	19
BCH2LD0233CA5C	19	BCH2LH2033CA6C	19	BCH2MM0613CA6C	19	BCH2MM2023CA6C	19	BCH2MR4513CA6C	19
BCH2LD0233CF5C	19	BCH2LH2033CF6C	19	BCH2MM0613CF6C	19	BCH2MM2023CF6C	19	BCH2MR4513CF6C	19
BCH2LD0233MA5C	19	BCH2LH2033MA6C	19	BCH2MM0613MA6C	19	BCH2MM2023MA6C	19	BCH2MR4513MA6C	19
BCH2LD0233MF5C	19	BCH2LH2033MF6C	19	BCH2MM0613MF6C	19	BCH2MM2023MF6C	19	BCH2MR4513MF6C	19
BCH2LD0430CA5C	19	BCH2MB0130CA5C	19	BCH2MM0810CA6C	19	BCH2MR2020CA6C	19	BCH2MR5512CA6C	19
BCH2LD0430CF5C	19	BCH2MB0130CF5C	19	BCH2MM0810CF6C	19	BCH2MR2020CF6C	19	BCH2MR5512CF6C	19
BCH2LD0431CA5C	19	BCH2MB0131CA5C	19	BCH2MM0811CA6C	19	BCH2MR2021CA6C	19	BCH2MR5512MA6C	19
BCH2LD0431CF5C	19	BCH2MB0131CF5C	19	BCH2MM0811CF6C	19	BCH2MR2021CF6C	19	BCH2MR5512MF6C	19
BCH2LD0432CA5C	19	BCH2MB0132CA5C	19	BCH2MM0812CA6C	19	BCH2MR2022CA6C	19	BCH2MR5513CA6C	19

Lexium 28 & Motors

Lexium 28 servo drives and BCH2 servo motors
Product reference index

BCH2MR5513CF6C	19	BCH2LH2033NA6C	19	LXM28SU02M3X	6	VW3E5001R005	15	VW3M8D2A	23
BCH2MR5513MA6C	19	BCH2MM1523NA6C	19		9	VW3E5001R010	15	VW3M8D2AR30	23
BCH2MR5513MF6C	19	BCH2MM2023NA6C	19		17	VW3E5001R015	15	VW3M8D2AR50	23
BCH2MR7512CA6C	19	BCH2MR3013NA6C	19	LXM28SU04M3X	6	VW3E5001R020	15	VW3M2207	10
BCH2MR7512CF6C	19	BCH2MR3023NA6C	19		9	VW3E5001R030	15	VW3M2501	10
BCH2MR7512MA6C	19	BCH2MR3523NA6C	19		17	VW3E5001R050	15	VW3M3103	21
BCH2MR7512MF6C	19	BCH2MR4513NA6C	19		6	VW3E5001R100	15	VW3M3805R010	13
BCH2MR7513CA6C	19				9	VW3E5001R150	15	VW3M3805R030	13
BCH2MR7513CF6C	19	L		LXM28SU10M3X	6	VW3E5001R200	15	VW3M7101R01	10
BCH2MR7513MA6C	19	LXM28AU01M3X	6		9	VW3E5001R250	15	VW3M7102R150	10
BCH2MR7513MF6C	19		9		17	VW3E5001R300	15		
BCH2HF0830CF5C	19	LXM28AU02M3X	6	LXM28SU15M3X	6	VW3E5001R400	15		
BCH2HF0831CA5C	19		9		9	VW3E5001R500	15		
BCH2HF0831CF5C	19	LXM28AU04M3X	6		17	VW3M1C10R10	10		
BCH2HF0832CA5C	19		9	LXM28SU20M3X	6	VW3M1C10R20	10		
BCH2HF0832CF5C	19	LXM28AU07M3X	6		9	VW3M1C10R30	10		
BCH2HF0833CA5C	19		9		17	VW3M1C12	10		
BCH2HF0833CF5C	19	LXM28AU10M3X	6	LXM28SU30M3X	6	VW3M1C13	10		
BCH2LB0130CA5C	19		9		9	VW3M1C20R10	10		
BCH2LB0130CF5C	19		17	LXM28SU45M3X	6	VW3M1C20R20	10		
BCH2LB0131CA5C	19	LXM28AU15M3X	6		9	VW3M1C20R30	10		
BCH2LB0131CF5C	19		9		17	VW3M5D1A	22		
BCH2LB0132CA5C	19		17	T			23		
BCH2LB0132CF5C	19	LXM28AU20M3X	6	TCSCAR013M120	13	VW3M5D1AR15	22		
BCH2LB0133CA5C	19		9	TCSMCNAM3M002P	11		23		
BCH2LB0133CF5C	19	LXM28AU30M3X	6	TSXCANCA50	13	VW3M5D1AR30	22		
BCH2LBA530CA5C	19		9	TSXCANCA100	13	VW3M5D1AR50	22		
BCH2LBA530CF5C	19		17	TSXCANCA300	13		23		
BCH2LBA531CA5C	19	LXM28AU45M3X	6	TSXCANCB50	13	VW3M5D1F	22		
BCH2LBA531CF5C	19		9	TSXCANCB100	13		23		
BCH2LBA532CA5C	19	LXM28AUA5M3X	6	TSXCANCB300	13	VW3M5D1FR30	22		
BCH2LBA532CF5C	19		9	TSXCANCD50	13		23		
BCH2LBA533CA5C	19	LXM28EU01M3X	6	TSXCANCD100	13	VW3M5D1FR50	22		
BCH2LBA533CF5C	19		9	TSXCANCD300	13		23		
BCH2LF0830CA5C	19		17	V		VW3M5D2A	22		
BCH2LF0830CF5C	19	LXM28EU02M3X	6	VW3A4420	16		23		
BCH2LF0831CA5C	19		9	VW3A4421	16	VW3M5D2AR30	22		
BCH2LF0831CF5C	19		17	VW3A4422	16		23		
BCH2LF0832CA5C	19	LXM28EU04M3X	6	VW3A4423	16	VW3M5D2AR50	22		
BCH2LF0832CF5C	19		9	VW3A7602R07	12		23		
BCH2LF0833CA5C	19	LXM28EU07M3X	6	VW3A7602R20	12	VW3M5D2B	23		
BCH2LF0833CF5C	19		9	VW3A7603R07	12	VW3M5D2FR30	22		
BCH2HM1020NA6C	19	LXM28EU10M3X	6	VW3A7603R20	12		23		
BCH2HM1020NF6C	19		9	VW3A7604R07	12	VW3M5D2FR50	22		
BCH2HM1021NA6C	19		17	VW3A7604R20	12		23		
BCH2HM1021NF6C	19	LXM28EU15M3X	6	VW3A7604R30	12	VW3M5D4AR30	22		
BCH2HM1022NA6C	19		9	VW3A7606R07	12		23		
BCH2HM1022NF6C	19	LXM28EU20M3X	6	VW3A7606R20	12	VW3M5D4AR50	22		
BCH2HM1023NA6C	19		17	VW3A7606R30	12		23		
BCH2HM1023NF6C	19	LXM28EU30M3X	6	VW3A7607R07	12	VW3M5D4FR30	22		
BCH2HR2020NA6C	19		9	VW3A7607R20	12		23		
BCH2HR2020NF6C	19		17	VW3A7607R30	12	VW3M5D6AR30	22		
BCH2HR2021NA6C	19	LXM28EU45M3X	6	VW3A7733	12		23		
BCH2HR2021NF6C	19		9	VW3A7734	12	VW3M5D6AR50	22		
BCH2HR2022NA6C	19		17	VW3A8121	11		23		
BCH2HR2022NF6C	19	LXM28EUA5M3X	6	VW3A8126	11	VW3M5D6FR30	22		
BCH2HR2023NA6C	19		9	VW3CANCARR1	13		23		
BCH2HR2023NF6C	19		17	VW3CANCARR03	13	VW3M8D1A	23		
BCH2HF0733NA5C	19	LXM28SU01M3X	6			VW3M8D1AR15	23		
BCH2LH1033NA6C	19		9			VW3M8D1AR30	23		
			17			VW3M8D1AR50	23		

Life Is On



Learn more about our products at
www.se.com

The information provided in this documentation contains general descriptions and/or technical characteristics of the performance of the products contained herein. This documentation is not intended as a substitute for and is not to be used for determining suitability or reliability of these products for specific user applications. It is the duty of any such user or integrator to perform the appropriate and complete risk analysis, evaluation and testing of the products with respect to the relevant specific application or use thereof. Neither Schneider Electric nor any of its affiliates or subsidiaries shall be responsible or liable for misuse of the information contained herein.

Design: Schneider Electric
Photos: Schneider Electric

Schneider Electric Industries SAS

Head Office
35, rue Joseph Monier - CS 30323
F-92500 Rueil-Malmaison Cedex
France

DIA7ED2150401EN
August 2022 - V6.0