



PASSION FOR POWER.

# Industrial enclosures for individual customisation

in accordance with IEC 62208



More information at [www.hensel-electric.de/en](http://www.hensel-electric.de/en)

 made in **GERMANY**

since 1931

# Industrial enclosures for individual customisation

offering highly individualized design options

The robust enclosures developed, manufactured and distributed by HENSEL are suitable as universal encapsulation to fulfill many demanding tasks in industrial and commercial sites. They protect individual installations of electrical devices and electronic components in manufacturing processes,

in the automation of machines and plants or in the industrial control sector. They are used as industrial, display and operating enclosures in a wide variety of industries, applications and environments. Configure your best product and find the best solution for your application!



# Customized solutions

tailored to meet individual needs in industrial processes

Enclosures made from thermoplastics can be easily and quickly machined for customized applications. Whether drilling, milling or sawing, the enclosures can be easily machined with conventional tools.

Wherever sensitive electronic or electrical components and other sensitive components need to be protected against external influences, Hensel's robust enclosures are used. The high quality enclosures offer the highest level of protection against dust and water, corrosion, impact and UV radiation. They can easily be used in extreme industrial environments and under tough conditions.



Enclosure with START-STOP button on a mobile and stationary vehicle.



Enclosure used as a control unit in a fertilizer factory.



Waste water treatment plant to start / stop the pumps.



SL PMA 16313

MALIF  
Machinery & Equipment  
MALIF Sdn Bhd  
No. 4, Jalan 1/10, Taman Puncakbendera Park,  
Kuala Lumpur, Wilayah Persekutuan  
Tel: +603-8033 8811 Fax: +603-8033 8813  
Email: info@malif.com Website: www.malif.com  
Seri No. 1170  
Model No.  
Year Manufactured 1170

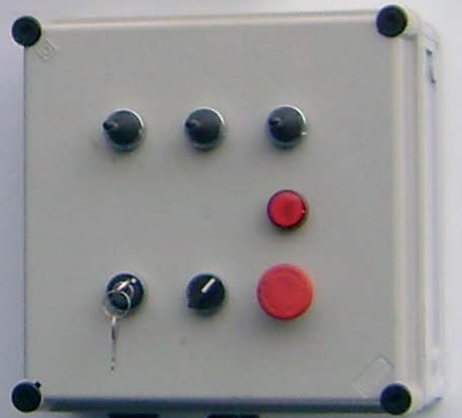

## Empty enclosures in accordance with IEC 62208

- for customized solutions and individual applications
- for example for low-voltage switchgear and controlgear assemblies in accordance with the IEC 61439-series
- degree of protection IP 55-IP 65
- made from thermoplastics
- protection class II, 

Introduction	2 - 3
Contents	4 - 5
General information to IEC 62208 standard	6 - 7
EB empty enclosures, box walls without knockouts, can be drilled individually	8 - 14
KG empty enclosures, cable entry via metric knockouts	15 - 18
K empty enclosures, box walls without knockouts, can be drilled individually	19 - 22
Accessories	23 - 44
Technical details	45 - 58
Application examples	56 - 57

Further technical information can be found on the Internet  
[www.hensel-electric.de](http://www.hensel-electric.de) -> Products

**IEC 62208**

Enclosures for low-voltage switchgear and controlgear assemblies.

General requirements

**General information**

The IEC 62208 standard applies to empty enclosures, prior to the incorporation of switchgear and controlgear components by the user, as supplied by the enclosure manufacturer.

It specifies general definitions, classifications, characteristics and test requirements of enclosures to be used as part of switchgear and controlgear assemblies (e.g. in accordance with the IEC 61439-series).

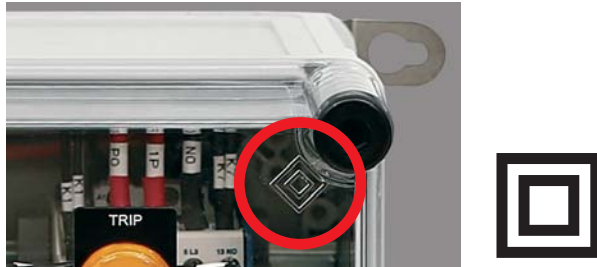

**Compliance with the safety requirements of the applicable product standard (e.g. IEC 61439-series) is the responsibility of the assembly manufacturer and not of the enclosure manufacturer.**



**Protection against electric shock**

In order to protect individuals in the event of faults against electric shock and the accompanying risks, enclosures are classified with protection class I (electrical earth) and protection class II (protection by total or reinforced insulation). HENSEL empty enclosures are manufactured from insulating material and provide protection against electric shock according to protection class II.



**IP-Codes for protecting electrical equipment against dust and water**

Electrical equipment must be protected from external influences and conditions for safety reasons. The two-digit IP-Codes indicate to what extent the enclosure provides protection against hazardous parts and ingress of dust (1st digit) or water (2nd digit). For example IP 65: Electrical equipment inside the enclosure is protected against dust and harmful water and humidity.

Therefore the IP-Codes indicate the suitability of enclosures for different environmental conditions.

**Effects on the degree of protection (IP-Code) when devices are built in the lid**

If any switches, displays, push buttons or other equipment are built into the lid of an enclosure, the manufacturer must consider the effects on the degree of protection at that specific point.

The installation of electrical equipment into the lid, door or wall of an enclosure can reduce the degree of protection of the enclosure in that specific installation area depending on the degree of protection of the equipment and depending on additional measures for sealing the point of entry.

Example: The installation of an IP 44 socket into the lid of an IP 65 enclosure reduces the degree of protection in that specific area to IP 44. The enclosure itself still provides IP 65, but the manufacturer has to draw attention to the fact, that the socket only provides IP 44 for the area where it is installed.

**Operating and ambient conditions**

Empty enclosures according to IEC 62208 are applicable in ambient temperatures from -25 °C to +40 °C (outdoor installation) or from -5 °C to +40 °C (indoor installation).

The IEC 62208 requires the specification of the power dissipation capability  $P_{de}$  of the enclosures

**Temperature rise in enclosures and power dissipation**

In relationship with the outside temperatures the temperature rise inside of enclosures, caused by the flowing current and the power loss  $P_D$  of the installed electrical equipment, has to be considered.

Most devices are designed for maximum ambient temperatures of +40 °C to +55 °C. Accordingly there may only be a narrow range for the temperature rise inside of the enclosure if the ambient temperature is close to the maximum operating temperature of the installed equipment.

The enclosure with its power dissipation capability  $P_{de}$  has to be able to dissipate the power loss  $P_D$  of the installed electrical equipment inside of the enclosure without exceeding the limits of operating and ambient temperatures.

This ensures that the inside of an enclosure is not heated inadmissibly at a defined installed power loss and guarantees the operative readiness and reliable performance of the built-in electrical equipment.

The power dissipation  $P_D$  of the electrical equipment is given in the technical data of the respective manufacturers. The power dissipation capability  $P_{de}$  of Hensel empty enclosures are given in the technical data of this catalogue.

The temperature inside of enclosures rises by the flowing current and the power loss of the installed electrical equipment.



The enclosure with its power dissipation capability  $P_{de}$  has to be able to dissipate the power loss  $P_D$  of the installed electrical equipment inside of the enclosure without exceeding the limits of operating and ambient temperatures.

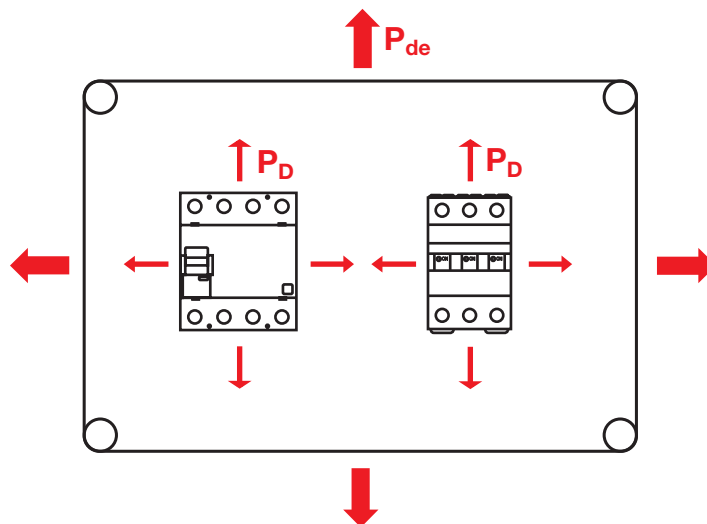

$P_{de}$  = power dissipation capability  
 $P_D$  = power dissipation

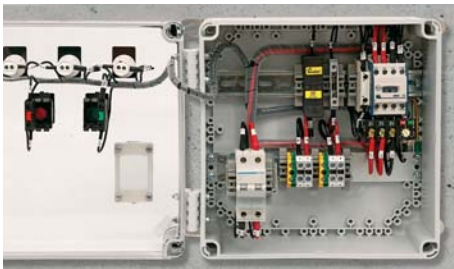
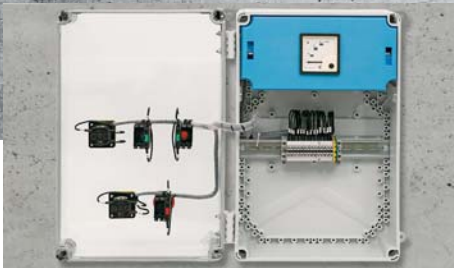
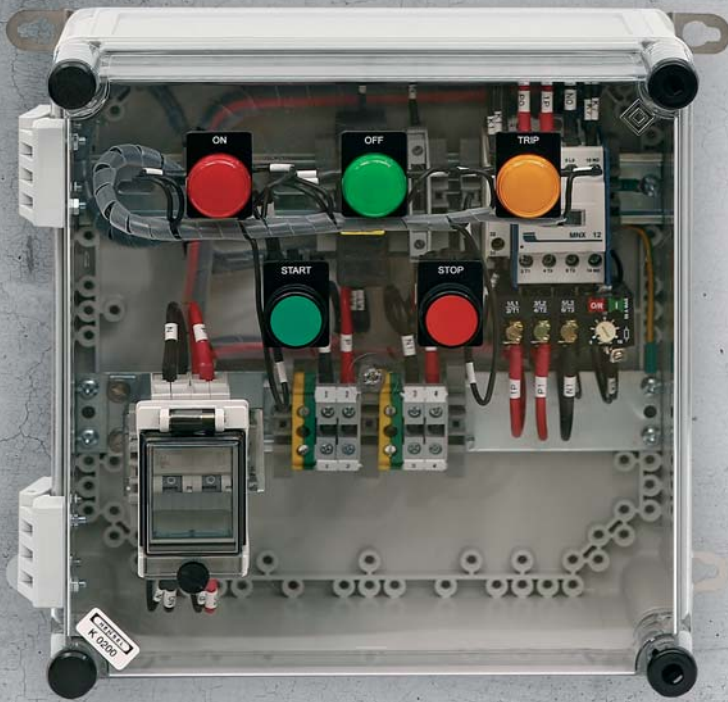

## ENYFLEX

### Empty enclosures in accordance with IEC 62208

For customized solutions and individual applications

- For low-voltage switchgear and controlgear assemblies, for example in accordance with IEC 61439-series
- For the installation of devices that must be operated externally, such as plug devices, push buttons and switches
- Installation of electrical equipment via DIN rails or mounting plates
- Cable entry via metric knockouts respectively by drilling individually using ESM grommets or AKM/ASS cable glands
- Fasteners for tool operation as standard
- Screws made of stainless steel V2A
- Hinges for K-series lids available for operating installation devices within a large area
- Material: PS polystyrene or PC polycarbonate, UV-resistant
- Burning behaviour:  
Glow wire test in accordance with IEC 60695-2-11: 750 °C / 960 °C, flame-retardant, self-extinguishing
- Empty enclosures are equipment with protection class II, & in accordance with IEC 61439-1, section 8.4.4
- Degree of protection: up to IP 66
- Colour: grey, RAL 7035 or black, RAL 9011





**EB 02 G**

**Built-in dimensions W 74 x H 74 x D 47 mm**

- for installation equipment on DIN rails or mounting plates (order separately)
- with opaque lid
- fastener for tool operation
- sealable
- box walls without knockouts
- external brackets for wall fixing included
- colour: grey, RAL 7035
- material: PC (polycarbonate)

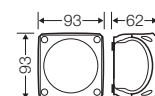

rated insulation voltage	$U_i = 1000 \text{ V a.c./d.c.}$
impact strength	IK 09 (10 Joule)
static load	mounting plate or DIN rail = 0.55 kg lid = 0.15 kg
power dissipation capability at $\Delta\theta = 40 \text{ K}$	$P_{de} = 3.5 \text{ watts}$
wall thickness	enclosure = 2 mm lid = 2 mm



**EB 04 G**

**Built-in dimensions W 83 x H 83 x D 55 mm**

- for installation equipment on DIN rails or mounting plates (order separately)
- with opaque lid
- fastener for tool operation
- sealable
- box walls without knockouts
- external brackets for wall fixing included
- colour: grey, RAL 7035
- material: PC (polycarbonate)

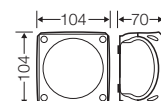

rated insulation voltage	$U_i = 1000 \text{ V a.c./d.c.}$
impact strength	IK 09 (10 Joule)
static load	mounting plate or DIN rail = 0.85 kg lid = 0.2 kg
power dissipation capability at $\Delta\theta = 40 \text{ K}$	$P_{de} = 4.5 \text{ watts}$
wall thickness	enclosure = 2 mm lid = 2 mm

Applicaton:



EB empty enclosure with emergency stop and START/STOP button



EB empty enclosure with an emergency stop



**EB 06 G**

**Built-in dimensions W 102 x H 102 x D 62 mm**

- for installation equipment on DIN rails or mounting plates (order separately)
- with opaque lid
- fastener for tool operation
- sealable
- box walls without knockouts
- external brackets for wall fixing included
- colour: grey, RAL 7035
- material: PC (polycarbonate)

rated insulation voltage	$U_i = 1000 \text{ V a.c./d.c.}$
impact strength	IK 09 (10 Joule)
static load	mounting plate or DIN rail = 1.6 kg lid = 0.4 kg
power dissipation capability at $\Delta\theta = 40 \text{ K}$	$P_{de} = 6 \text{ watts}$
wall thickness	enclosure = 2 mm lid = 2 mm

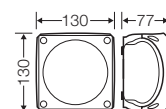

**EB 10 G**

**Built-in dimensions W 97 x H 150 x D 62 mm**

- for installation equipment on DIN rails or mounting plates (order separately)
- with opaque lid
- fastener for tool operation
- sealable
- box walls without knockouts
- external brackets for wall fixing included
- colour: grey, RAL 7035
- material: PC (polycarbonate)

rated insulation voltage	$U_i = 1000 \text{ V a.c./d.c.}$
impact strength	IK 09 (10 Joule)
static load	mounting plate or DIN rail = 2.2 kg lid = 0.6 kg
power dissipation capability at $\Delta\theta = 40 \text{ K}$	$P_{de} = 8 \text{ watts}$
wall thickness	enclosure = 2 mm lid = 2 mm

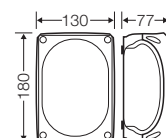

**EB 25 G**

**Built-in dimensions W 170 x H 220 x D 96 mm**

- for installation equipment on DIN rails or mounting plates (order separately)
- with opaque lid
- fastener for tool operation
- sealable
- box walls without knockouts
- external brackets for wall fixing included
- colour: grey, RAL 7035
- material: PC (polycarbonate)

rated insulation voltage	$U_i = 1000 \text{ V a.c./d.c.}$
impact strength	IK 09 (10 Joule)
static load	mounting plate or DIN rail = 4.4 kg lid = 1.2 kg
power dissipation capability at $\Delta\theta = 40 \text{ K}$	$P_{de} = 20 \text{ watts}$
wall thickness	enclosure = 2,5 mm lid = 2 mm

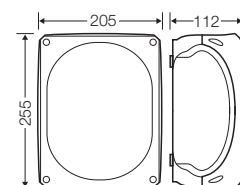

**Empty enclosures in accordance with IEC 62208**  
**for customized solutions and individual applications**  
**Box walls without knockouts, can be drilled individually**



**EB 35 G**

**Built-in dimensions W 190 x H 260 x D 106 mm**

- for installation equipment on DIN rails or mounting plates (order separately)
- with opaque lid
- fastener for tool operation
- sealable
- box walls without knockouts
- external brackets for wall fixing included
- colour: grey, RAL 7035
- material: PC (polycarbonate)

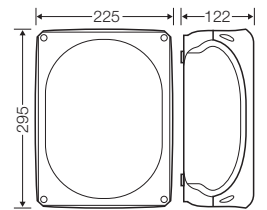

rated insulation voltage	$U_i = 1000 \text{ V a.c./d.c.}$
impact strength	IK 09 (10 Joule)
static load	mounting plate or DIN rail = 5.1 kg lid = 1.7 kg
power dissipation capability at $\Delta\theta = 40 \text{ K}$	$P_{de} = 24 \text{ watts}$
wall thickness	enclosure = 2,8 mm lid = 2 mm



**EB 50 G**

**Built-in dimensions W 215 x H 320 x D 106 mm**

- for installation equipment on DIN rails or mounting plates (order separately)
- with opaque lid
- fastener for tool operation
- sealable
- box walls without knockouts
- external brackets for wall fixing included
- colour: grey, RAL 7035
- material: PC (polycarbonate)

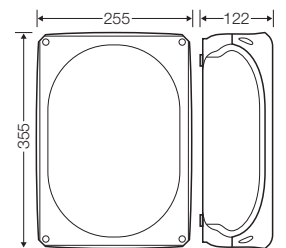

rated insulation voltage	$U_i = 1000 \text{ V a.c./d.c.}$
impact strength	IK 09 (10 Joule)
static load	mounting plate or DIN rail = 6.5 kg lid = 2.1 kg
power dissipation capability at $\Delta\theta = 40 \text{ K}$	$P_{de} = 27 \text{ watts}$
wall thickness	enclosure = 3 mm lid = 2 mm

Applicaton:



EB empty enclosure with emergency stop and START/STOP button



EB empty enclosure with an emergency stop



**EB 02 B**

**Built-in dimensions W 74 x H 74 x D 47 mm**

- for installation equipment on DIN rails or mounting plates (order separately)
- with opaque lid
- fastener for tool operation
- sealable
- box walls without knockouts
- external brackets for wall fixing included
- colour: black, RAL 9011
- material: PC (polycarbonate)

rated insulation voltage	$U_i = 1000 \text{ V a.c./d.c.}$
impact strength	IK 09 (10 Joule)
static load	mounting plate or DIN rail = 0.55 kg lid = 0.15 kg
power dissipation capability at $\Delta\theta = 40 \text{ K}$	$P_{de} = 3.5 \text{ watts}$
wall thickness	enclosure = 2 mm lid = 2 mm

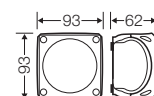

**EB 04 B**

**Built-in dimensions W 83 x H 83 x D 55 mm**

- for installation equipment on DIN rails or mounting plates (order separately)
- with opaque lid
- fastener for tool operation
- sealable
- box walls without knockouts
- external brackets for wall fixing included
- colour: black, RAL 9011
- material: PC (polycarbonate)

rated insulation voltage	$U_i = 1000 \text{ V a.c./d.c.}$
impact strength	IK 09 (10 Joule)
static load	mounting plate or DIN rail = 0.85 kg lid = 0.2 kg
power dissipation capability at $\Delta\theta = 40 \text{ K}$	$P_{de} = 4.5 \text{ watts}$
wall thickness	enclosure = 2 mm lid = 2 mm

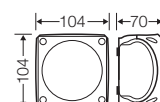

**EB 06 B**

**Built-in dimensions W 102 x H 102 x D 62 mm**

- for installation equipment on DIN rails or mounting plates (order separately)
- with opaque lid
- fastener for tool operation
- sealable
- box walls without knockouts
- external brackets for wall fixing included
- colour: black, RAL 9011
- material: PC (polycarbonate)

rated insulation voltage	$U_i = 1000 \text{ V a.c./d.c.}$
impact strength	IK 09 (10 Joule)
static load	mounting plate or DIN rail = 1.6 kg lid = 0.4 kg
power dissipation capability at $\Delta\theta = 40 \text{ K}$	$P_{de} = 6 \text{ watts}$
wall thickness	enclosure = 2 mm lid = 2 mm

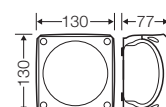



**EB 10 B**

**Built-in dimensions W 97 x H 150 x D 62 mm**

- for installation equipment on DIN rails or mounting plates (order separately)
- with opaque lid
- fastener for tool operation
- sealable
- box walls without knockouts
- external brackets for wall fixing included
- colour: black, RAL 9011
- material: PC (polycarbonate)

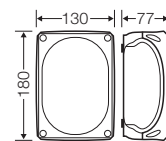

rated insulation voltage	$U_i = 1000 \text{ V a.c./d.c.}$
impact strength	IK 09 (10 Joule)
static load	mounting plate or DIN rail = 2.2 kg lid = 0.6 kg
power dissipation capability at $\Delta\theta = 40 \text{ K}$	$P_{de} = 8 \text{ watts}$
wall thickness	enclosure = 2 mm lid = 2 mm



**EB 25 B**

**Built-in dimensions W 170 x H 220 x D 96 mm**

- for installation equipment on DIN rails or mounting plates (order separately)
- with opaque lid
- fastener for tool operation
- sealable
- box walls without knockouts
- external brackets for wall fixing included
- colour: black, RAL 9011
- material: PC (polycarbonate)

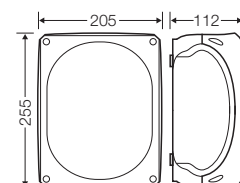

rated insulation voltage	$U_i = 1000 \text{ V a.c./d.c.}$
impact strength	IK 09 (10 Joule)
static load	mounting plate or DIN rail = 4.4 kg lid = 1.2 kg
power dissipation capability at $\Delta\theta = 40 \text{ K}$	$P_{de} = 20 \text{ watts}$
wall thickness	enclosure = 2,5 mm lid = 2 mm

Applicaton:



EB empty enclosure with emergency stop and START/STOP button



EB empty enclosure with an emergency stop



**EB 35 B**

**Built-in dimensions W 190 x H 260 x D 106 mm**

- for installation equipment on DIN rails or mounting plates (order separately)
- with opaque lid
- fastener for tool operation
- sealable
- box walls without knockouts
- external brackets for wall fixing included
- colour: black, RAL 9011
- material: PC (polycarbonate)

rated insulation voltage	$U_i = 1000 \text{ V a.c./d.c.}$
impact strength	IK 09 (10 Joule)
static load	mounting plate or DIN rail = 5.1 kg lid = 1.7 kg
power dissipation capability at $\Delta\theta = 40 \text{ K}$	$P_{de} = 24 \text{ watts}$
wall thickness	enclosure = 2,8 mm lid = 2 mm

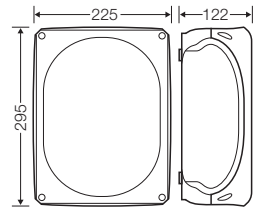

**EB 50 B**

**Built-in dimensions W 215 x H 320 x D 106 mm**

- for installation equipment on DIN rails or mounting plates (order separately)
- with opaque lid
- fastener for tool operation
- sealable
- box walls without knockouts
- external brackets for wall fixing included
- colour: black, RAL 9011
- material: PC (polycarbonate)

rated insulation voltage	$U_i = 1000 \text{ V a.c./d.c.}$
impact strength	IK 09 (10 Joule)
static load	mounting plate or DIN rail = 6.5 kg lid = 2.1 kg
power dissipation capability at $\Delta\theta = 40 \text{ K}$	$P_{de} = 27 \text{ watts}$
wall thickness	enclosure = 3 mm lid = 2 mm

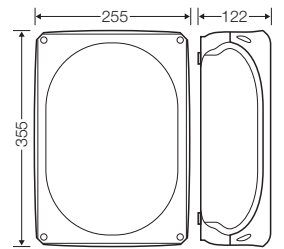



**KG 9001**

**Built-in dimensions W 101 x H 205 x D 95 mm**

- for installation equipment on DIN rails or mounting plates (order separately)
- max. installation depth with built-in mounting plate 95 mm, with built-in DIN rail 89 mm
- with transparent hinged lid
- fastener for tool operation
- sealable
- cable entry via metric knockouts
- included cable entry:  
 2 ESM 25, sealing range  $\varnothing$  9-17 mm and  
 1 ESM 32, sealing range  $\varnothing$  9-23 mm
- colour: grey, RAL 7035
- material: PS (polystyrene)

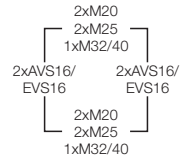
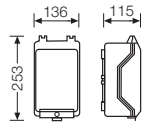

rated insulation voltage	$U_i = 1000 \text{ V a.c./d.c.}$
impact strength	IK 08 (5 Joule)
static load	mounting plate or DIN rail = 1.3 kg lid = 1.2 kg
power dissipation capability at $\Delta\theta = 40 \text{ K}$	$P_{de} = 16.5 \text{ watts}$
wall thickness	enclosure = 3 mm lid = 3 mm



**KG 9002**

**Built-in dimensions W 133 x H 205 x D 95 mm**

- for installation equipment on DIN rails or mounting plates (order separately)
- max. installation depth with built-in mounting plate 95 mm, with built-in DIN rail 89 mm
- please order DIN rails or mounting plates additionally
- with transparent hinged lid
- fastener for tool operation
- sealable
- cable entry via metric knockouts
- included cable entry:  
 2 ESM 25, sealing range  $\varnothing$  9-17 mm and  
 1 ESM 32, sealing range  $\varnothing$  9-23 mm
- colour: grey, RAL 7035
- material: PS (polystyrene)

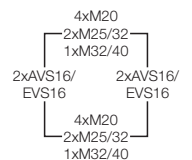
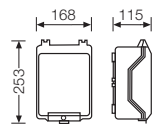

rated insulation voltage	$U_i = 1000 \text{ V a.c./d.c.}$
impact strength	IK 08 (5 Joule)
static load	mounting plate or DIN rail = 1.6 kg lid = 1.2 kg
power dissipation capability at $\Delta\theta = 40 \text{ K}$	$P_{de} = 16.8 \text{ watts}$
wall thickness	enclosure = 3 mm lid = 3 mm

Applicaton:



KG empty enclosures with transparent lid



KG empty enclosures with opaque lid



**KG 9003**

**Built-in dimensions W 182 x H 205 x D 95 mm**

- for installation equipment on DIN rails or mounting plates (order separately)
- max. installation depth with built-in mounting plate 95 mm, with built-in DIN rail 89 mm
- please order DIN rails or mounting plates additionally
- with transparent hinged lid
- fastener for tool operation
- sealable
- cable entry via metric knockouts
- included cable entry:  
 2 ESM 25, sealing range Ø 9-17 mm and  
 1 ESM 32, sealing range Ø 9-23 mm
- colour: grey, RAL 7035
- material: PS (polystyrene)

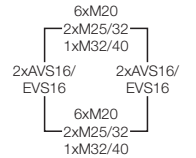
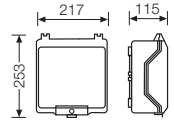

rated insulation voltage	$U_i = 1000 \text{ V a.c./d.c.}$
impact strength	IK 08 (5 Joule)
static load	mounting plate or DIN rail = 1.6 kg lid = 1.6 kg
power dissipation capability at $\Delta\theta = 40 \text{ K}$	$P_{de} = 17.6 \text{ watts}$
wall thickness	enclosure = 3 mm lid = 3 mm

Installation example:



Installation example::







**KG 9001 IN**

**Built-in dimensions W 101 x H 205 x D 95 mm**

- for installation equipment on DIN rails or mounting plates (order separately)
- max. installation depth with built-in mounting plate 95 mm, with built-in DIN rail 89 mm
- with opaque hinged lid
- fastener for tool operation
- sealable
- cable entry via metric knockouts
- included cable entry:  
 2 ESM 25, sealing range Ø 9-17 mm and  
 1 ESM 32, sealing range Ø 9-23 mm
- colour: grey, RAL 7035
- material: PS (polystyrene)

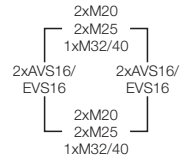
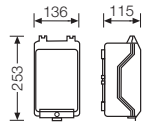

rated insulation voltage	$U_i = 1000 \text{ V a.c./d.c.}$
impact strength	IK 08 (5 Joule)
static load	mounting plate or DIN rail = 1.3 kg lid = 1.2 kg
power dissipation capability at $\Delta\theta = 40 \text{ K}$	$P_{de} = 16.5 \text{ watts}$
wall thickness	enclosure = 3 mm lid = 3 mm



**KG 9002 IN**

**Built-in dimensions W 133 x H 205 x D 95 mm**

- for installation equipment on DIN rails or mounting plates (order separately)
- max. installation depth with built-in mounting plate 95 mm, with built-in DIN rail 89 mm
- with opaque hinged lid
- fastener for tool operation
- sealable
- cable entry via metric knockouts
- included cable entry:  
 2 ESM 25, sealing range Ø 9-17 mm and  
 1 ESM 32, sealing range Ø 9-23 mm
- colour: grey, RAL 7035
- material: PS (polystyrene)

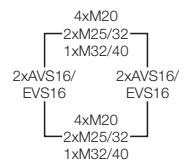
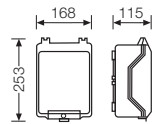

rated insulation voltage	$U_i = 1000 \text{ V a.c./d.c.}$
impact strength	IK 08 (5 Joule)
static load	mounting plate or DIN rail = 1.6 kg lid = 1.2 kg
power dissipation capability at $\Delta\theta = 40 \text{ K}$	$P_{de} = 16.8 \text{ watts}$
wall thickness	enclosure = 3 mm lid = 3 mm

Application:



KG empty enclosures with transparent lid



KG empty enclosures with opaque lid



**KG 9003 IN**

**Built-in dimensions W 182 x H 205 x D 95 mm**

- for installation equipment on DIN rails or mounting plates (order separately)
- max. installation depth with built-in mounting plate 95 mm, with built-in DIN rail 89 mm
- with opaque hinged lid
- fastener for tool operation
- sealable
- cable entry via metric knockouts
- included cable entry:  
 2 ESM 25, sealing range  $\varnothing$  9-17 mm and  
 1 ESM 32, sealing range  $\varnothing$  9-23 mm
- colour: grey, RAL 7035
- material: PS (polystyrene)

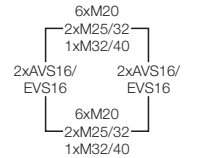
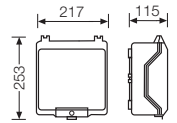

rated insulation voltage	$U_i = 1000$ V a.c./d.c.
impact strength	IK 08 (5 Joule)
static load	mounting plate or DIN rail = 1.6 kg lid = 1.6 kg
power dissipation capability at $\Delta\theta = 40$ K	$P_{de} = 17.6$ watts
wall thickness	enclosure = 3 mm lid = 3 mm

Installation example:



Installation example:





**K 0100**

**Built-in dimensions W 275 x H 125 x D 150 mm**

- enclosure size 1, type Mi
- for installation equipment on DIN rails or mounting plates (order separately)
- max. installation depth with built-in mounting plate 146 mm, with built-in DIN rail 135 mm
- with transparent lid
- lid fasteners for tool operation
- sealable
- box walls without knockouts
- optional hinges for device installation in the lid
- external brackets for wall fixing as accessories
- colour: grey, RAL 7035
- material: PC (polycarbonate)

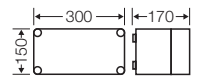

rated insulation voltage	U <sub>i</sub> = 690 V a.c. / 1000 V d.c.
impact strength	IK 08 (5 Joule)
static load	mounting plate or DIN rail = 3.2 kg lid = 1.3 kg
power dissipation capability at Δθ = 40 K	P <sub>de</sub> = 33 watts
wall thickness	enclosure = 3 mm lid = 3 mm



**K 0101**

**Built-in dimensions W 275 x H 125 x D 150 mm**

- enclosure size 1, type Mi
- for installation equipment on DIN rails or mounting plates (order separately)
- max. installation depth with built-in mounting plate 146 mm, with built-in DIN rail 135 mm
- with opaque lid
- lid fasteners for tool operation
- sealable
- box walls without knockouts
- optional hinges for device installation in the lid
- external brackets for wall fixing as accessories
- colour: grey, RAL 7035
- material: PC (polycarbonate)

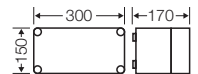

rated insulation voltage	U <sub>i</sub> = 690 V a.c. / 1000 V d.c.
impact strength	IK 08 (5 Joule)
static load	mounting plate or DIN rail = 3.2 kg lid = 1.3 kg
power dissipation capability at Δθ = 40 K	P <sub>de</sub> = 33 watts
wall thickness	enclosure = 3 mm lid = 3 mm

Applicaton:



Empty enclosures with installed equipment on DIN rail and mounting plate



DIN rails for equipment or terminals with clip-on mounting



Device installation on mounting plates



**K 0200**

**Built-in dimensions W 275 x H 275 x D 150 mm**

- enclosure size 2, type Mi
- for installation equipment on DIN rails or mounting plates (order separately)
- max. installation depth with built-in mounting plate 146 mm, with built-in DIN rail 135 mm
- with transparent lid
- lid fasteners for tool operation
- sealable
- box walls without knockouts
- optional hinges for device installation in the lid
- external brackets for wall fixing as accessories
- colour: grey, RAL 7035
- material: PC (polycarbonate)

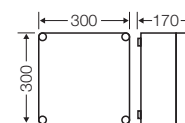

rated insulation voltage	$U_i = 690 \text{ V a.c.} / 1000 \text{ V d.c.}$
impact strength	IK 08 (5 Joule)
static load	mounting plate or DIN rail = 6.5 kg lid = 1.6 kg
power dissipation capability at $\Delta\theta = 40 \text{ K}$	$P_{de} = 53 \text{ watts}$
wall thickness	enclosure = 3 mm lid = 3 mm



**K 0201**

**Built-in dimensions W 275 x H 275 x D 150 mm**

- enclosure size 2, type Mi
- for installation equipment on DIN rails or mounting plates (order separately)
- max. installation depth with built-in mounting plate 146 mm, with built-in DIN rail 135 mm
- with opaque lid
- lid fasteners for tool operation
- sealable
- box walls without knockouts
- optional hinges for device installation in the lid
- external brackets for wall fixing as accessories
- colour: grey, RAL 7035
- material: PC (polycarbonate)

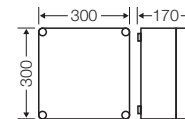

rated insulation voltage	$U_i = 690 \text{ V a.c.} / 1000 \text{ V d.c.}$
impact strength	IK 08 (5 Joule)
static load	mounting plate or DIN rail = 6.5 kg lid = 1.6 kg
power dissipation capability at $\Delta\theta = 40 \text{ K}$	$P_{de} = 53 \text{ watts}$
wall thickness	enclosure = 3 mm lid = 3 mm

**Empty enclosures in accordance with IEC 62208  
for customized solutions and individual applications  
Box walls without knockouts, can be drilled individually**



**K 0300**

**Built-in dimensions W 275 x H 425 x D 150 mm**

- enclosure size 3, type Mi
- for installation equipment on DIN rails or mounting plates (order separately)
- max. installation depth with built-in mounting plate 146 mm, with built-in DIN rail 135 mm
- with transparent lid
- lid fasteners for tool operation
- sealable
- box walls without knockouts
- optional hinges for device installation in the lid
- external brackets for wall fixing as accessories
- colour: grey, RAL 7035
- material: PC (polycarbonate)

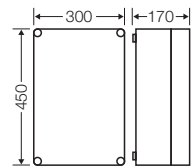

rated insulation voltage	$U_i = 690 \text{ V a.c.} / 1000 \text{ V d.c.}$
impact strength	IK 08 (5 Joule)
static load	mounting plate or DIN rail = 9.2 kg lid = 3.2 kg
power dissipation capability at $\Delta\theta = 40 \text{ K}$	$P_{de} = 71 \text{ watts}$
wall thickness	enclosure = 3 mm lid = 3 mm



**K 0301**

**Built-in dimensions W 275 x H 425 x D 150 mm**

- enclosure size 3, type Mi
- for installation equipment on DIN rails or mounting plates (order separately)
- max. installation depth with built-in mounting plate 146 mm, with built-in DIN rail 135 mm
- with opaque lid
- lid fasteners for tool operation
- sealable
- box walls without knockouts
- optional hinges for device installation in the lid
- external brackets for wall fixing as accessories
- colour: grey, RAL 7035
- material: PC (polycarbonate)

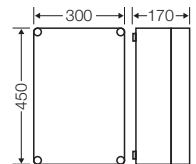

rated insulation voltage	$U_i = 690 \text{ V a.c.} / 1000 \text{ V d.c.}$
impact strength	IK 08 (5 Joule)
static load	mounting plate or DIN rail = 9.2 kg lid = 3.2 kg
power dissipation capability at $\Delta\theta = 40 \text{ K}$	$P_{de} = 71 \text{ watts}$
wall thickness	enclosure = 3 mm lid = 3 mm

Applicaton:



Empty enclosures with installed equipment on DIN rail and mounting plate



DIN rails for equipment or terminals with clip-on mounting



Device installation on mounting plates



**K 0400**

**Built-in dimensions W 275 x H 575 x D 150 mm**

- enclosure size 4, type Mi
- for installation equipment on DIN rails or mounting plates (order separately)
- max. installation depth with built-in mounting plate 146 mm, with built-in DIN rail 135 mm
- with transparent lid
- lid fasteners for tool operation
- sealable
- box walls without knockouts
- optional hinges for device installation in the lid
- external brackets for wall fixing as accessories
- colour: grey, RAL 7035
- material: PC (polycarbonate)

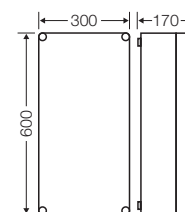

rated insulation voltage	$U_i = 690 \text{ V a.c.} / 1000 \text{ V d.c.}$
impact strength	IK 08 (5 Joule)
static load	mounting plate or DIN rail = 9.2 kg lid = 3.2 kg
power dissipation capability at $\Delta\theta = 40 \text{ K}$	$P_{de} = 93 \text{ watts}$
wall thickness	enclosure = 3 mm lid = 3 mm



**K 0401**

**Built-in dimensions W 275 x H 575 x D 150 mm**

- enclosure size 4, type Mi
- for installation equipment on DIN rails or mounting plates (order separately)
- max. installation depth with built-in mounting plate 146 mm, with built-in DIN rail 135 mm
- with opaque lid
- lid fasteners for tool operation
- sealable
- box walls without knockouts
- optional hinges for device installation in the lid
- external brackets for wall fixing as accessories
- colour: grey, RAL 7035
- material: PC (polycarbonate)

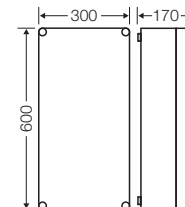

rated insulation voltage	$U_i = 690 \text{ V a.c.} / 1000 \text{ V d.c.}$
impact strength	IK 08 (5 Joule)
static load	mounting plate or DIN rail = 9.2 kg lid = 3.2 kg
power dissipation capability at $\Delta\theta = 40 \text{ K}$	$P_{de} = 93 \text{ watts}$
wall thickness	enclosure = 3 mm lid = 3 mm

Installation example:

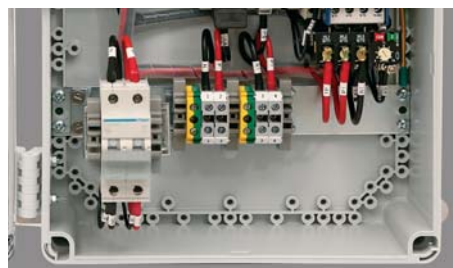



## Empty enclosures in accordance with IEC 62208

### Accessories

#### for EB empty enclosures

DIN rails	24
Mounting plates	25
Mounting kits for pipe and post installation	26

#### for KG empty enclosures

Mounting plates, DIN rails	27
PE and N terminals	28

#### for K empty enclosures

DIN rails	29
Mounting plates	30
External fixing, sealing, conversion sets for lid fasteners lid locks	31
Lid fasteners, multikey, conversionset for padlock, mounting kits for pipe and post installation	32
Hinges, extension frame	33
Cable entry systems (grommets, cable glands, combi climate glands)	34 - 44



**DK TS 01**

**DIN rail**

- for DK 02....., DK 04....., KF 02....., KF 04....., EB 02.., EB 04..
- for the installation of terminal blocks
- with fixing screws

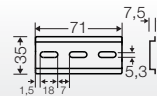

**DK TS 02**

**DIN rail**

- for DK 02....., KF 02....., EB 02..
- for the installation of terminal blocks
- with fixing screws



**DK TS 04**

**DIN rail**

- for DK 04 ....., KF 04....., EB 04..
- for the installation of terminal blocks
- with fixing screws



**DK TS 06**

**DIN rail**

- for DK 06.... , KF 06....., EB 06..
- for the installation of terminal blocks
- with fixing screws

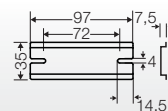

**DK TS 10**

**DIN rail**

- for DK 10....., KF 10....., EB 10..
- for the installation of terminal blocks
- with fixing screws

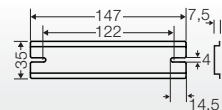

**DK TS 25**

**DIN rail**

- for DK 25....., KF 25....., EB 25..
- for the installation of terminal blocks
- with fixing screws

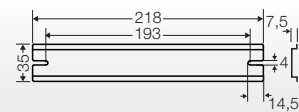

**DK TS 35**

**DIN rail**

- for DK 35....., KF 35....., EB 35..
- for the installation of terminal blocks
- with fixing screws

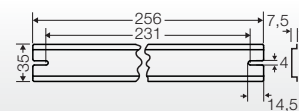

**DK TS 50**

**DIN rail**

- for DK 50....., KF 50....., EB 50..
- for the installation of terminal blocks
- with fixing screws

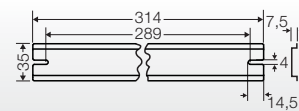





**EB MP 02**

**Mounting plate W 71.5 x H 71.5 mm**

- material thickness 4 mm
- for EB 02.. empty boxes
- with fixing screws



material	laminated paper, coated
----------	-------------------------



**EB MP 04**

**Mounting plate W 81 x H 81 mm**

- material thickness 4 mm
- for EB 04.. empty boxes
- with fixing screws



material	laminated paper, coated
----------	-------------------------



**EB MP 06**

**Mounting plate W 104.5 x H 104.5 mm**

- material thickness 4 mm
- for EB 06.. empty boxes
- with fixing screws



material	laminated paper, coated
----------	-------------------------



**EB MP 10**

**Mounting plate W 104,5 x H 154,5 mm**

- material thickness 4 mm
- for EB 10.. empty boxes
- with fixing screws

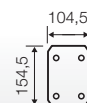

material	laminated paper, coated
----------	-------------------------



**EB MP 25**

**Mounting plate W 174.5 x H 224.5 mm**

- material thickness 4 mm
- for EB 25.. empty boxes
- with fixing screws

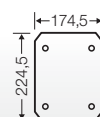

material	laminated paper, coated
----------	-------------------------



**EB MP 35**

**Mounting plate W 192 x H 262 mm**

- material thickness 4 mm
- for EB 35.. empty boxes
- with fixing screws

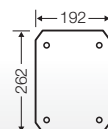

material	laminated paper, coated
----------	-------------------------



**EB MP 50**

**Mounting plate W 319.5 x H 219.5 mm**

- material thickness 4 mm
- for EB 50.. empty boxes
- with fixing screws

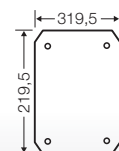

material	laminated paper, coated
----------	-------------------------



**DK MB 1**

**Mounting kit  
for pipe and post installation**

- for cable junction boxes DK 02.. X, KF 02.. X, WP 02.. X, EB 02 X
- for cable junction boxes DK 04.. X, KF 04.. X, WP 04.. X, EB 04 X
- for cable junction boxes DK 06.. X, KF 06.. X, WP 06.. X, EB 06 X
- suitable for pipe/pole diameters of 60 - 150 mm
- clamps and fixing screws included

material

stainless steel V2A

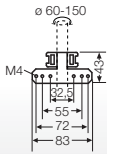

**DK MB 2**

**Mounting kit  
for pipe and post installation**

- for cable junction boxes DK 10.. X, KF 10.. X, WP 10.. X, EB 10 X
- for cable junction boxes DK 16.. X, KF 16.. X
- suitable for pipe/pole diameters of 60 - 150 mm
- clamps and fixing screws included

material

stainless steel V2A

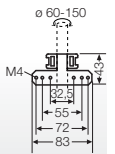

**DK MB 3**

**Mounting kit  
for pipe and post installation**

- for cable junction boxes DK 25.. X, KF 25.. X, EB 25 X
- for cable junction boxes DK 35.. X, KF 35.. X, EB 35 X
- for cable junction boxes DK 50.. X, KF 50.. X, EB 50 X
- suitable for pipe/pole diameters of 60 - 150 mm
- clamps and fixing screws included

material

stainless steel V2A

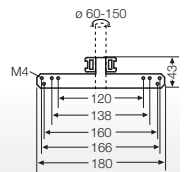

Anwendung:



Lighting control of a sports field



Power supply of a surveillance camera in public area



**KG MP 01**

**Mounting plate**  
**W 100 x H 136 mm**

- material thickness 4 mm
- for KG 9001 empty enclosures
- with fixing screws

material	laminated paper, coated
----------	-------------------------

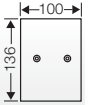

**KG MP 02**

**Mounting plate**  
**W 130 x H 136 mm**

- material thickness 4 mm
- for KG 9002 empty enclosures
- with fixing screws

material	laminated paper, coated
----------	-------------------------

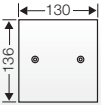

**KG MP 03**

**Mounting plate**  
**W 180 x H 136 mm**

- material thickness 4 mm
- for KG 9003 empty enclosures
- with fixing screws

material	laminated paper, coated
----------	-------------------------

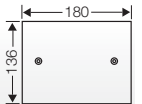

**KG TS 01**

**DIN rail for KG 9001**

- in accordance with DIN EN 60715
- for equipment or terminals with clip-on mounting
- with fixing screws

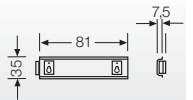

**KG TS 02**

**DIN rail for KG 9002**

- in accordance with DIN EN 60715
- for equipment or terminals with clip-on mounting
- with fixing screws



**KG TS 03**

**DIN rail for KG 9003**

- in accordance with DIN EN 60715
- for equipment or terminals with clip-on mounting
- with fixing screws

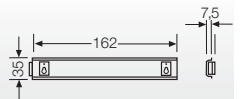



### **KG PN 01**

#### **PE and N terminal**

- for KG 9001
- per PE/N number x cross section 3 x 25 mm<sup>2</sup>, 3 x 4 mm<sup>2</sup> Cu, screw-type terminal

rated insulation voltage

$U_i = 400 \text{ V a.c.}$



### **KG PN 02**

#### **PE and N terminal**

- for KG 9002
- per PE/N number x cross section 3 x 25 mm<sup>2</sup>, 5 x 4 mm<sup>2</sup> Cu, screw-type terminal

rated insulation voltage

$U_i = 400 \text{ V a.c.}$



### **KG PN 03**

#### **PE and N terminal**

- for KG 9003
- per PE/N number x cross section 4 x 25 mm<sup>2</sup>, 7 x 4 mm<sup>2</sup> Cu, screw-type terminal

rated insulation voltage

$U_i = 400 \text{ V a.c.}$



**Mi TS 15**

**DIN rail**  
**length 134 mm**

- in accordance with DIN EN 60715
- for Mi-Empty boxes sizes 1, 6
- for equipment or terminals with clip-on mounting
- with fixing screws

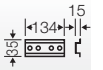

**Mi TS 30**

**DIN rail**  
**length 284 mm**

- in accordance with DIN EN 60715
- for Mi-Empty boxes sizes 1, 2, 3, 4, 6, 8
- for equipment or terminals with clip-on mounting
- with fixing screws



**Mi TS 45**

**DIN rail**  
**length 434 mm**

- in accordance with DIN EN 60715
- for Mi-Empty boxes sizes 3, 6
- for equipment or terminals with clip-on mounting
- with fixing screws



**Mi TS 60**

**DIN rail**  
**length 584 mm**

- in accordance with DIN EN 60715
- for Mi-Empty boxes sizes 4, 6, 8
- for equipment or terminals with clip-on mounting
- with fixing screws

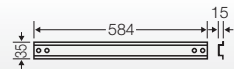

Applicaton:



DIN rails for equipment  
 or terminals with clip-on  
 mounting



**Mi MP 1**

**Mounting plate**  
**W 259 x H 115 mm**

- material thickness 4 mm
- for Mi-Empty boxes sizes 1, 2, 3, 4, 6
- with fixing screws



material	laminated paper, coated
----------	-------------------------



**Mi MP 2**

**Mounting plate**  
**W 265 x H 265 mm**

- material thickness 4 mm
- for Mi-Empty boxes sizes 2, 3, 4, 6, 8
- with fixing screws

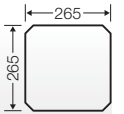

material	laminated paper, coated
----------	-------------------------



**Mi MP 3**

**Mounting plate**  
**W 265 x H 415 mm**

- material thickness 4 mm
- for Mi-Empty boxes sizes 3, 4, 6
- with fixing screws

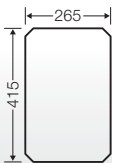

material	laminated paper, coated
----------	-------------------------



**Mi MP 4**

**Mounting plate**  
**W 265 x H 565 mm**

- material thickness 4 mm
- for Mi-Empty boxes sizes 4, 6, 8
- with fixing screws

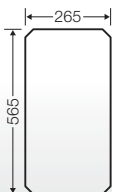

material	laminated paper, coated
----------	-------------------------

Applicaton:



Device installation on mounting plates



**Mi PL 2**

**Sealing cap**

- 2 sealing caps for converting the lid fasteners



**Mi SR 4**

**Conversion set  
for hand operation on tool operation**

- 4 fastening covers



**Mi SN 4**

**Conversion set  
for converting lid fasteners from tool to manual operation**

- 4 manual actuators

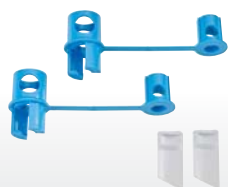

**Mi SV 2**

**Conversion set  
for padlock (clip Ø max. 10 mm)**

- 2 fastening covers
- can be used instead of fasteners for hand or tool operation in order to prevent unauthorised opening of the lids

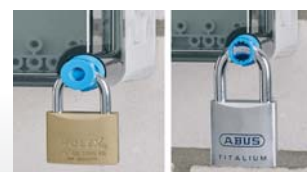

**Mi DV 01**

**Locking device insertion**

- only in connection with Mi PL 2, Mi SR 4 or Mi SN 4



**Mi ZS 11**

**Lid lock  
with locking device I  
for Mi boxes sizes 1 to 6**

- can be used instead of fasteners for hand or tool operation in order to prevent unauthorised opening of the lids
- consisting of: cylinder lock, keys, locking device insertion, dust cover



**Mi ZS 12**

**Lid lock  
with locking device II  
for Mi boxes sizes 1 to 6**

- can be used instead of fasteners for hand or tool operation in order to prevent unauthorised opening of the lids
- consisting of: cylinder lock, keys, locking device insertion, dust cover



**Mi DR 04**

**Lid fastener for tool operation  
triangle 8 mm**

- is being used in place of fasteners for hand- or tool operation to prevent unauthorized opening of lids
- 4 locking devices with triangle 8 mm and key





**DS 1**  
Triangular key 8 mm

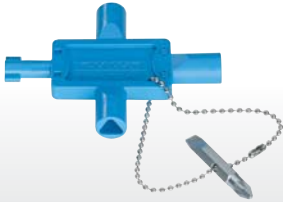

**US 1**  
Multikey  

- triangular 8 mm, square 8 mm, double-bit and slot



**Mi AL 40**  
4 stainless steel external brackets  

- for external fixing of enclosures

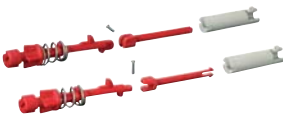
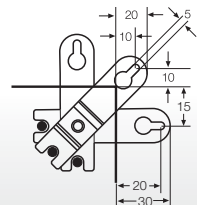

**Mi ZS 20**  
Mi hinge for lids  
for Mi boxes sizes 1, 2, 3, 4  

- For operating installation device within a large area. The lid keeps permanently connected to the box.
- When assembling several boxes, the insertion can only be carried out for the external boxes.



**Mi ZS 30**  
Hinge for lids  

- for empty boxes K 0xxx
- with lamellar plugs for 2 lid fixing tubes
- The lid keeps permanently connected to the box



**Mi ZR 4**  
Extension frame  
for enclosure size 4  

- for extension of the installation depth by 85 mm
- degree of protection IP 65 is maintained with use of up to two extension frames
- inclusive fixing material

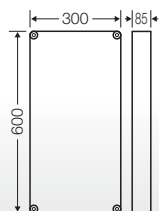





**Mi MB 1**  
**Mounting kit**  
**for pipe and post installation**

- for Mi boxes
- for enclosure width 150 mm
- suitable for pipe/pole diameters of 60 - 150 mm
- clamps and fixing screws included

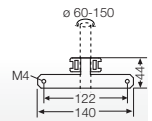

material

stainless steel V2A



**Mi MB 2**  
**Mounting kit**  
**for pipe and post installation**

- for Mi boxes
- for enclosure width 300 mm
- suitable for pipe/pole diameters of 60 - 150 mm
- clamps and fixing screws included

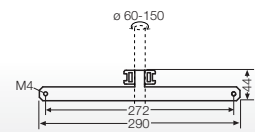

material

stainless steel V2A

Anwendung:



Control street lighting



Street lighting in a commercial area

**ESM 16****Grommets  
for knockouts M 16**

- sealing range: Ø 4.8-11 mm
- bore-hole: Ø 16.5 mm
- wall thickness 1.5-3.5 mm
- for indoor - normal environment and (or) protected outdoor installation
- ambient temperature - 25 °C to + 35 °C
- glow wire test IEC 60695-2-11: 750 °C
- colour: grey, RAL 7035

IP  
55**ESM 20****Grommets  
for knockouts M 20**

- sealing range: Ø 6-13 mm
- bore-hole: Ø 20.5 mm
- wall thickness 1.5-3.5 mm
- for indoor - normal environment and (or) protected outdoor installation
- ambient temperature - 25 °C to + 35 °C
- glow wire test IEC 60695-2-11: 750 °C
- colour: grey, RAL 7035

IP  
55**ESM 25****Grommets  
for knockouts M 25**

- sealing range: Ø 9-17 mm
- bore-hole: Ø 25.5 mm
- wall thickness 1.5-3.5 mm
- for indoor - normal environment and (or) protected outdoor installation
- ambient temperature - 25 °C to + 35 °C
- glow wire test IEC 60695-2-11: 750 °C
- colour: grey, RAL 7035

IP  
55**ESM 32****Grommets  
for knockouts M 32**

- sealing range: Ø 9-23 mm
- bore-hole: Ø 32.5 mm
- wall thickness 1.5-3.5 mm
- for indoor - normal environment and (or) protected outdoor installation
- ambient temperature - 25 °C to + 35 °C
- glow wire test IEC 60695-2-11: 750 °C
- colour: grey, RAL 7035

IP  
55**ESM 40****Grommets  
for knockouts M 40**

- sealing range: Ø 17-30 mm
- bore-hole: Ø 40.5 mm
- wall thickness 1.5-3.5 mm
- for indoor - normal environment and (or) protected outdoor installation
- ambient temperature - 25 °C to + 35 °C
- glow wire test IEC 60695-2-11: 750 °C
- colour: grey, RAL 7035

IP  
55



**AKM 12**

**Cable glands for knockouts M 12**



- sealing range: Ø 4-6 mm
- ISO thread M 12 x 1.5
- bore-hole: Ø 12.3 mm
- wall thickness up to 3 mm
- with strain relief and locknut
- for indoor (normal environment and/or protected outdoor) and outdoor installation (harsh environment and/or outdoor)
- ambient temperature - 25 °C to + 55 °C
- glow wire test IEC 60695-2-11: 960 °C
- colour: grey, RAL 7035



tightening torque	0,9 Nm
-------------------	--------



**AKM 16**

**Cable glands for knockouts M 16**



- sealing range: Ø 5-10 mm
- ISO thread M 16 x 1.5
- bore-hole: Ø 16.3 mm
- wall thickness up to 3 mm
- with strain relief and locknut
- for indoor (normal environment and/or protected outdoor) and outdoor installation (harsh environment and/or outdoor)
- ambient temperature - 25 °C to + 55 °C
- glow wire test IEC 60695-2-11: 960 °C
- colour: grey, RAL 7035



tightening torque	3,0 Nm
-------------------	--------



**AKM 20**

**Cable glands for knockouts M 20**



- sealing range Ø 6,5-13,5 mm
- ISO thread M 20 x 1.5
- bore-hole: Ø 20.3 mm
- wall thickness up to 3 mm
- with strain relief and locknut
- for indoor (normal environment and/or protected outdoor) and outdoor installation (harsh environment and/or outdoor)
- ambient temperature - 25 °C to + 55 °C
- glow wire test IEC 60695-2-11: 960 °C
- colour: grey, RAL 7035



tightening torque	4,0 Nm
-------------------	--------



**AKM 25**

**Cable glands for knockouts M 25**



- sealing range Ø 11-17 mm
- ISO thread M 25 x 1.5
- bore-hole: Ø 25.3 mm
- wall thickness up to 3 mm
- with strain relief and locknut
- for indoor (normal environment and/or protected outdoor) and outdoor installation (harsh environment and/or outdoor)
- ambient temperature - 25 °C to + 55 °C
- glow wire test IEC 60695-2-11: 960 °C
- colour: grey, RAL 7035



tightening torque	7,5 Nm
-------------------	--------



### AKM 32

#### Cable glands for knockouts M 32



- sealing range  $\varnothing$  15-21 mm
- ISO thread M 32 x 1.5
- bore-hole:  $\varnothing$  32.3 mm
- wall thickness up to 3 mm
- with strain relief and locknut
- for indoor (normal environment and/or protected outdoor) and outdoor installation (harsh environment and/or outdoor)
- ambient temperature - 25 °C to + 55 °C
- glow wire test IEC 60695-2-11: 960 °C
- colour: grey, RAL 7035



tightening torque	10,0 Nm
-------------------	---------



### AKM 40

#### Cable glands for knockouts M 40



- sealing range:  $\varnothing$  19-28 mm
- ISO thread M 40 x 1.5
- bore-hole:  $\varnothing$  40.3 mm
- wall thickness up to 3 mm
- with strain relief and locknut
- for indoor (normal environment and/or protected outdoor) and outdoor installation (harsh environment and/or outdoor)
- ambient temperature - 25 °C to + 55 °C
- glow wire test IEC 60695-2-11: 960 °C
- colour: grey, RAL 7035



tightening torque	10,0 Nm
-------------------	---------



### AKM 50

#### Cable glands for knockouts M 50



- sealing range:  $\varnothing$  27-35 mm
- ISO thread M 50 x 1.5
- bore-hole:  $\varnothing$  50.3 mm
- wall thickness up to 3 mm
- with strain relief and locknut
- for indoor (normal environment and/or protected outdoor) and outdoor installation (harsh environment and/or outdoor)
- ambient temperature - 25 °C to + 55 °C
- glow wire test IEC 60695-2-11: 960 °C
- colour: grey, RAL 7035



tightening torque	10,0 Nm
-------------------	---------



### AKM 63

#### Cable glands for knockouts M 63



- sealing range:  $\varnothing$  35-42 mm
- ISO thread M 63 x 1.5
- bore-hole:  $\varnothing$  63.3 mm
- wall thickness up to 3 mm
- with strain relief and locknut
- for indoor (normal environment and/or protected outdoor) and outdoor installation (harsh environment and/or outdoor)
- ambient temperature - 25 °C to + 55 °C
- glow wire test IEC 60695-2-11: 960 °C
- colour: grey, RAL 7035



tightening torque	10,0 Nm
-------------------	---------



**ASS 12**

**Cable glands for knockouts M 12**



- sealing range: Ø 2-5 mm
- ISO thread M 12 x 1.5
- bore-hole: Ø 12.3 mm
- wall thickness up to 3 mm
- with strain relief and locknut
- for indoor (normal environment and/or protected outdoor) and outdoor installation (harsh environment and/or outdoor)
- ambient temperature - 25 °C to + 55 °C
- glow wire test IEC 60695-2: 960 °C
- colour: black, RAL 9005



tightening torque	0,9 Nm
-------------------	--------



**ASS 16**

**Cable glands for knockouts M 16**



- sealing range: Ø 3-10 mm
- ISO thread M 16 x 1.5
- bore-hole: Ø 16.3 mm
- wall thickness up to 3 mm
- with strain relief and locknut
- for indoor (normal environment and/or protected outdoor) and outdoor installation (harsh environment and/or outdoor)
- ambient temperature - 25 °C to + 55 °C
- glow wire test IEC 60695-2: 960 °C
- colour: black, RAL 9005



tightening torque	3,0 Nm
-------------------	--------



**ASS 20**

**Cable glands for knockouts M 20**



- sealing range: Ø 5-13 mm
- ISO thread M 20 x 1.5
- bore-hole: Ø 20.3 mm
- wall thickness up to 3 mm
- with strain relief and locknut
- for indoor (normal environment and/or protected outdoor) and outdoor installation (harsh environment and/or outdoor)
- ambient temperature - 25 °C to + 55 °C
- glow wire test IEC 60695-2: 960 °C
- colour: black, RAL 9005



tightening torque	4,0 Nm
-------------------	--------



**ASS 25**

**Cable glands for knockouts M 25**



- sealing range: Ø 8-17 mm
- ISO thread M 25 x 1.5
- bore-hole: Ø 25.3 mm
- wall thickness up to 3 mm
- with strain relief and locknut
- for indoor (normal environment and/or protected outdoor) and outdoor installation (harsh environment and/or outdoor)
- ambient temperature - 25 °C to + 55 °C
- glow wire test IEC 60695-2: 960 °C
- colour: black, RAL 9005



tightening torque	7,5 Nm
-------------------	--------



**ASS 32**

**Cable glands for knockouts M 32**



- sealing range: Ø 12-21 mm
- ISO thread M 32 x 1.5
- bore-hole: Ø 32.3 mm
- wall thickness up to 3 mm
- with strain relief and locknut
- for indoor (normal environment and/or protected outdoor) and outdoor installation (harsh environment and/or outdoor)
- ambient temperature - 25 °C to + 55 °C
- glow wire test IEC 60695-2: 960 °C
- colour: black, RAL 9005



tightening torque	10,0 Nm
-------------------	---------



**ASS 40**

**Cable glands for knockouts M 40**



- sealing range: Ø 16-28,5 mm
- ISO thread M 40 x 1.5
- bore-hole: Ø 40.3 mm
- wall thickness up to 3 mm
- with strain relief and locknut
- for indoor (normal environment and/or protected outdoor) and outdoor installation (harsh environment and/or outdoor)
- ambient temperature - 25 °C to + 55 °C
- glow wire test IEC 60695-2: 960 °C
- colour: black, RAL 9005



tightening torque	10,0 Nm
-------------------	---------



**ASS 50**

**Cable glands for knockouts M 50**



- sealing range: Ø 21-35 mm
- ISO thread M 50 x 1.5
- bore-hole: Ø 50.3 mm
- wall thickness up to 3 mm
- with strain relief and locknut
- for indoor (normal environment and/or protected outdoor) and outdoor installation (harsh environment and/or outdoor)
- ambient temperature - 25 °C to + 55 °C
- glow wire test IEC 60695-2: 960 °C
- colour: black, RAL 9005



tightening torque	10,0 Nm
-------------------	---------



**ASS 63**

**Cable glands for knockouts M 63**



- sealing range: Ø 20-48 mm
- ISO thread M 63 x 1.5
- bore-hole: Ø 63.3 mm
- wall thickness up to 3 mm
- with counter nut
- for indoor (normal environment and/or protected outdoor) and outdoor installation (harsh environment and/or outdoor)
- ambient temperature - 25 °C to + 55 °C
- glow wire test IEC 60695-2: 960 °C
- colour: black, RAL 9005



tightening torque	10,0 Nm
-------------------	---------



### KBM 20

#### Combi climate gland for knockouts M 20

- to reduce condensation through pressure compensation
- sealing range: Ø 6-13 mm
- ISO thread M 20 x 1.5
- bore-hole: Ø 20.5 mm
- wall thickness up to 3,5 mm
- with strain relief and locknut
- for indoor (normal environment and/or protected outdoor) and outdoor installation (harsh environment and/or outdoor)
- ambient temperature - 25 °C to + 55 °C
- glow wire test IEC 60695-2: 960 °C
- In order not to exceed leakage limit of 0.07 bar with pressure compensation, one combi climate gland M20 must be used per 6 litres (6000 cm<sup>3</sup>) of enclosure volume.
- Example: enclosure size 27 cm x 27 cm x 17 cm = 12393 cm<sup>3</sup> = 12,393 litres. Number of necessary combi climate glands KB. 20 (M20) ≥ 3 pieces.
- When using different gland sizes the values for the enclosure volumes of the used combi climate glands can be added on.
- If the quantity of the necessary climate glands for pressure compensation is larger, than the number of necessary cable glands for cable entry, the unused climate glands can be sealed with sealing plugs.
- colour: grey, RAL 7035

tightening torque

3,0 Nm

IP  
66/67



### KBM 25

#### Combi climate gland for knockouts M 25

- to reduce condensation through pressure compensation
- sealing range: Ø 9-17 mm
- ISO thread M 25 x 1.5
- bore-hole: Ø 25.5 mm
- wall thickness up to 3,5 mm
- with strain relief and locknut
- for indoor (normal environment and/or protected outdoor) and outdoor installation (harsh environment and/or outdoor)
- ambient temperature - 25 °C to + 55 °C
- glow wire test IEC 60695-2: 960 °C
- In order not to exceed leakage limit of 0.07 bar with pressure compensation, one combi climate gland M25 must be used per 10 litres (10000 cm<sup>3</sup>) of enclosure volume.
- Example: enclosure size 27 cm x 27 cm x 17 cm = 12393 cm<sup>3</sup> = 12,393 litres. Number of necessary combi climate glands KB. 25 (M25) ≥ 2 pieces
- When using different gland sizes the values for the enclosure volumes of the used combi climate glands can be added on.
- If the quantity of the necessary climate glands for pressure compensation is larger, than the number of necessary cable glands for cable entry, the unused climate glands can be sealed with sealing plugs.
- colour: grey, RAL 7035

tightening torque

4,0 Nm

IP  
66/67





### KBM 32

#### Combi climate gland for knockouts M 32

- to reduce condensation through pressure compensation
- sealing range: Ø 13-21 mm
- ISO thread M 32 x 1.5
- bore-hole: Ø 32.5 mm
- wall thickness up to 3,5 mm
- with strain relief and locknut
- for indoor (normal environment and/or protected outdoor) and outdoor installation (harsh environment and/or outdoor)
- ambient temperature - 25 °C to + 55 °C
- glow wire test IEC 60695-2: 960 °C
- In order not to exceed leakage limit of 0.07 bar with pressure compensation, one combi climate gland M32 must be used per 12 litres (12000 cm<sup>3</sup>) of enclosure volume.
- Example: enclosure size 27 cm x 27 cm x 17 cm = 12393 cm<sup>3</sup> = 12,393 litres. Number of necessary combi climate glands KB. 32 (M32) ≥ 2 piece.
- When using different gland sizes the values for the enclosure volumes of the used combi climate glands can be added on.
- If the quantity of the necessary climate glands for pressure compensation is larger, than the number of necessary cable glands for cable entry, the unused climate glands can be sealed with sealing plugs.
- colour: grey, RAL 7035

tightening torque

4,0 Nm

IP  
66/67



### KBM 40

#### Combi climate gland for knockouts M 40

- to reduce condensation through pressure compensation
- sealing range: Ø 16-28 mm
- ISO thread M 40 x 1.5
- bore-hole: Ø 40.5 mm
- wall thickness up to 3 mm
- with strain relief and locknut
- for indoor (normal environment and/or protected outdoor) and outdoor installation (harsh environment and/or outdoor)
- ambient temperature - 25 °C to + 55 °C
- glow wire test IEC 60695-2: 960 °C
- In order not to exceed leakage limit of 0.07 bar with pressure compensation, one combi climate gland M40 must be used per 16 litres (16000 cm<sup>3</sup>) of enclosure volume.
- Example: enclosure size 27 cm x 27 cm x 17 cm = 12393 cm<sup>3</sup> = 12.393 litres. Number of necessary KB. 40 (M40) ≥ 1 piece.
- When using different gland sizes the values for the enclosure volumes of the used combi climate glands can be added on.
- If the quantity of the necessary climate glands for pressure compensation is larger, than the number of necessary cable glands for cable entry, the unused climate glands can be sealed with sealing plugs.
- colour: grey, RAL 7035

tightening torque

6,0 Nm

IP  
66/67



Application:



Combi climate glands





### KBS 20

#### Combi climate gland for knockouts M 20

- to reduce condensation through pressure compensation
- sealing range: Ø 6-13 mm
- ISO thread M 20 x 1.5
- bore-hole: Ø 20.5 mm
- wall thickness up to 3,5 mm
- with strain relief and locknut
- for indoor (normal environment and/or protected outdoor) and outdoor installation (harsh environment and/or outdoor)
- ambient temperature - 25 °C to + 55 °C
- glow wire test IEC 60695-2: 960 °C
- In order not to exceed leakage limit of 0.07 bar with pressure compensation, one combi climate gland M20 must be used per 6 litres (6000 cm<sup>3</sup>) of enclosure volume.
- Example: enclosure size 27 cm x 27 cm x 17 cm = 12393 cm<sup>3</sup> = 12,393 litres. Number of necessary combi climate glands KB. 20 (M20) ≥ 3 pieces.
- When using different gland sizes the values for the enclosure volumes of the used combi climate glands can be added on.
- If the quantity of the necessary climate glands for pressure compensation is larger, than the number of necessary cable glands for cable entry, the unused climate glands can be sealed with sealing plugs.
- colour: black, RAL 9005

tightening torque

3,0 Nm

IP  
66/67



### KBS 25

#### Combi climate gland for knockouts M 25

- to reduce condensation through pressure compensation
- sealing range: Ø 9-17 mm
- ISO thread M 25 x 1.5
- bore-hole: Ø 25.5 mm
- wall thickness up to 3,5 mm
- with strain relief and locknut
- for indoor (normal environment and/or protected outdoor) and outdoor installation (harsh environment and/or outdoor)
- ambient temperature - 25 °C to + 55 °C
- glow wire test IEC 60695-2: 960 °C
- In order not to exceed leakage limit of 0.07 bar with pressure compensation, one combi climate gland M25 must be used per 10 litres (10000 cm<sup>3</sup>) of enclosure volume.
- Example: enclosure size 27 cm x 27 cm x 17 cm = 12393 cm<sup>3</sup> = 12,393 litres. Number of necessary combi climate glands KB. 25 (M25) ≥ 2 pieces
- When using different gland sizes the values for the enclosure volumes of the used combi climate glands can be added on.
- If the quantity of the necessary climate glands for pressure compensation is larger, than the number of necessary cable glands for cable entry, the unused climate glands can be sealed with sealing plugs.
- colour: black, RAL 9005

tightening torque

4,0 Nm

IP  
66/67





### KBS 32

#### Combi climate gland for knockouts M 32

- to reduce condensation through pressure compensation
- sealing range: Ø 13-21 mm
- ISO thread M 32 x 1.5
- bore-hole: Ø 32.5 mm
- wall thickness up to 3,5 mm
- with strain relief and locknut
- for indoor (normal environment and/or protected outdoor) and outdoor installation (harsh environment and/or outdoor)
- ambient temperature - 25 °C to + 55 °C
- glow wire test IEC 60695-2: 960 °C
- In order not to exceed leakage limit of 0.07 bar with pressure compensation, one combi climate gland M32 must be used per 12 litres (12000 cm<sup>3</sup>) of enclosure volume.
- Example: enclosure size 27 cm x 27 cm x 17 cm = 12393 cm<sup>3</sup> = 12,393 litres. Number of necessary combi climate glands KB. 32 (M32) ≥ 2 piece.
- When using different gland sizes the values for the enclosure volumes of the used combi climate glands can be added on.
- If the quantity of the necessary climate glands for pressure compensation is larger, than the number of necessary cable glands for cable entry, the unused climate glands can be sealed with sealing plugs.
- colour: black, RAL 9005

IP  
66/67



tightening torque

4,0 Nm



### KBS 40

#### Combi climate gland for knockouts M 40

- to reduce condensation through pressure compensation
- sealing range: Ø 16-28 mm
- ISO thread M 40 x 1.5
- bore-hole: Ø 40.5 mm
- wall thickness up to 3 mm
- with strain relief and locknut
- for indoor (normal environment and/or protected outdoor) and outdoor installation (harsh environment and/or outdoor)
- ambient temperature - 25 °C to + 55 °C
- glow wire test IEC 60695-2: 960 °C
- In order not to exceed leakage limit of 0.07 bar with pressure compensation, one combi climate gland M40 must be used per 16 litres (16000 cm<sup>3</sup>) of enclosure volume.
- Example: enclosure size 27 cm x 27 cm x 17 cm = 12393 cm<sup>3</sup> = 12.393 litres. Number of necessary KB. 40 (M40) ≥ 1 piece.
- When using different gland sizes the values for the enclosure volumes of the used combi climate glands can be added on.
- If the quantity of the necessary climate glands for pressure compensation is larger, than the number of necessary cable glands for cable entry, the unused climate glands can be sealed with sealing plugs.
- colour: black, RAL 9005

IP  
66/67



tightening torque

6,0 Nm

Applicaton:



Combi climate glands

**VSB 13****Sealing plug  
diameter 13 mm**

- for sealing combi climate glands M20 or M25, which are not used for cable entry
- ambient temperature - 25 °C to + 55 °C
- colour: red, RAL 3000

**VSB 21****Sealing plug  
diameter 21 mm**

- for sealing combi climate glands M32 and M40, which are not used for cable entry
- ambient temperature - 25 °C to + 55 °C
- colour: red, RAL 3000



### BM 20G

#### Pressure compensation element for M 20 knockouts

- for the reduction of condensation by pressure compensation in power distribution systems
- ISO thread M 20 x 1.5
- bore-hole:  $\varnothing$  20.3 mm
- wall thickness up to 4 mm
- with counter nut
- for indoor (normal environment and/or protected outdoor) and outdoor installation (harsh environment and/or outdoor)
- ambient temperature - 25 °C to + 55 °C
- In order not to exceed leakage limit of 0.07 bar with pressure compensation, one pressure compensation element BM 20G must be used per 28 litres (28000 cm<sup>3</sup>) of enclosure volume.
- Example:  
enclosure size 30 cm x 60 cm x 17 cm = 30600 cm<sup>3</sup> = 30.6 litres.  
Number of necessary BM 20G (M32) = 2 piece.
- technical changes reserved
- colour: grey, RAL 7035

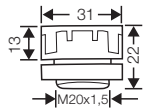

### BM 40G

#### Pressure compensation element for M 40 knockouts

- for the reduction of condensation by pressure compensation in power distribution systems
- ISO thread M 40 x 1.5
- bore-hole:  $\varnothing$  40.3 mm
- wall thickness of up to 8 mm
- with counter nut
- for indoor (normal environment and/or protected outdoor) and outdoor installation (harsh environment and/or outdoor)
- ambient temperature - 25 °C to + 55 °C
- In order not to exceed leakage limit of 0.07 bar with pressure compensation, one pressure compensation element BM 40G must be used per 122 litres (122000 cm<sup>3</sup>) of enclosure volume.
- Example:  
enclosure size 60 cm x 60 cm x 17 cm = 61200 cm<sup>3</sup> = 61.2 litres.  
Number of necessary BM 40G (M40) = 1 piece.
- technical changes reserved
- colour: grey, RAL 7035

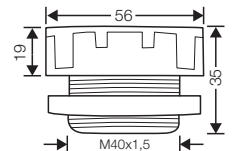

Pressure compensation elements reduce condensation in power distribution systems





## Empty enclosures in accordance with IEC 62208

### Technical details

Operating and ambient conditions	46 - 47
Dimensions in mm for EB empty enclosures	58 - 51
Power dissipation	52 - 53
Recommendation for outdoor installations, formation of condensed water	54 - 55
Application examples	56 - 57
Material properties	58

	Empty enclosures EB ...	Empty enclosures KG ...	Empty enclosures K ...
<b>Application area</b>	Suitable for outdoor installation (harsh environment and/or outdoor). To reduce the formation and accumulation of condensed water see pages 55-56.	<b>Suitable for indoor installation and outdoor installation, protected against weather influences</b> However, pay attention to the climatic effects on the installed equipment, for example, high or low ambient temperatures or formation of condensed water see pages 55-56.	
<b>Resistant to occasional cleaning procedures</b>	<b>Resistance to occasional cleaning procedures (direct jet)</b> with high-pressure cleaner without cleaning additives, water pressure: max 100 bar, water temperature: max 80 °C, distance ≥ 0.15 m, in accordance with DIN EN 60529:2014-09 (IEC 60529:2013) = IP 69. <b>Box and cable entries at least IP 66.</b>		
<b>Ambient temperature</b>			
- Average value over 24 hours	+ 55 °C	—	+35 °C
- Maximum value	+ 70 °C	+60 °C	+40 °C
- Minimum value	- 25 °C	-25 °C	-25 °C
<b>Relative humidity</b>	50% at 40 °C	—	50% at 40 °C
- short-time	100% at 25 °C	—	100% at 25 °C
<b>Fire protection</b> in the event of internal faults	Demands placed on electrical devices from standards and laws: Minimum requirements - Glow wire test in accordance with IEC 60695-2-11: - 650 °C for boxes and cable glands - 850 °C for conducting components		
<b>Burning behaviour</b>			
- Glow wire test IEC 60 695-2-11	960 °C	750 °C	960 °C
- UL Subject 94	V-0 flame-retardant self-extinguishing	V-2 flame-retardant self-extinguishing	V-2 flame-retardant self-extinguishing
<b>Degree of protection against mechanical load</b>	IK09 (10 Joule)	IK 08 (5 Joule)	IK 08 (5 Joule)
<b>Toxic behaviour</b>	halogen-free <sup>1)</sup> silicone-free	halogen-free <sup>1)</sup> silicone-free	halogen-free <sup>1)</sup> silicone-free

<sup>1)</sup> "Halogen-free" in accordance with IEC 60754-2"  
Common test methods for cables - Determination of the amount of halogen acid gas".

For material properties see page 45.

	ESM ...	AKM ... ASS ...	AKS ... KBM ... / KBS ... BM ..G
<b>Application area</b>	Suitable for indoor installation (normal environment and/or protected outdoor)	Suitable for <b>outdoor installation</b> - harsh environment and / or outdoor	
<b>Ambient temperature</b> - Average value over 24 hours - Maximum value - Minimum value	+ 35 °C + 40 °C - 25 °C	+ 55 °C + 70 °C - 25 °C	+ 55 °C + 70 °C - 25 °C
<b>Fire protection</b> in the event of internal faults	Demands placed on electrical devices from standards and laws:  Minimum requirements - Glow wire test in accordance with IEC 60695-2-11: - 650 °C for boxes and cable glands		
<b>Burning behaviour</b> - Glow wire test IEC 60695-2-11 - UL Subject 94	750 °C - flame-retardant self-extinguishing	960 °C V-0 flame-retardant self-extinguishing	960 °C V-2 flame-retardant self-extinguishing
<b>Toxic behaviour</b>	halogen-free silicone-free	halogen-free silicone-free	halogen-free silicone-free
	<sup>1)</sup> "Halogen-free" in accordance with IEC 60754-2" Common test methods for cables - Determination of the amount of halogen acid gas".  For material properties see page 45.		





Dimensions of the usable installation space in walls

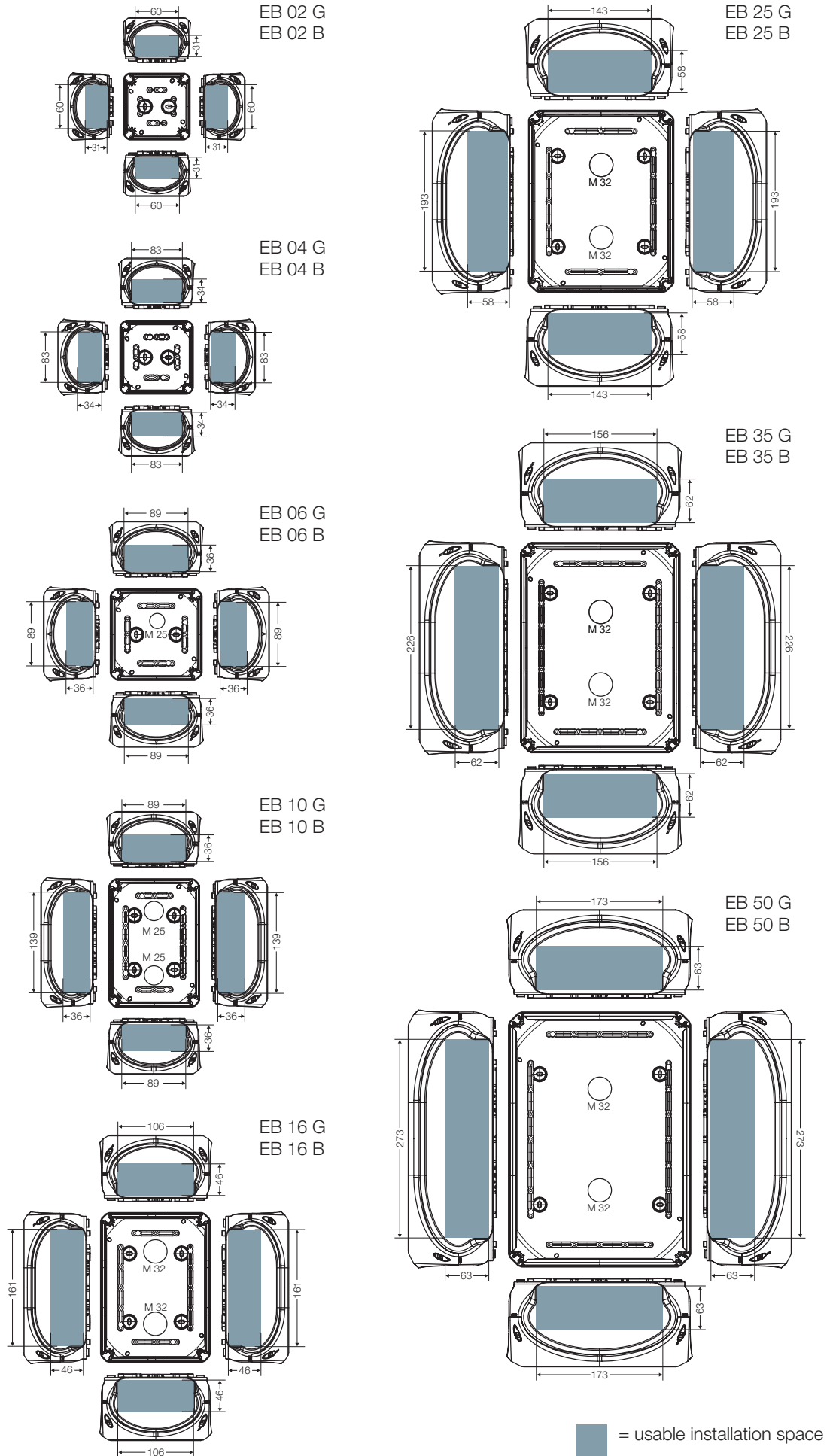

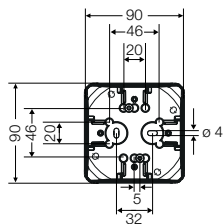

EB 02 G  
EB 02 B

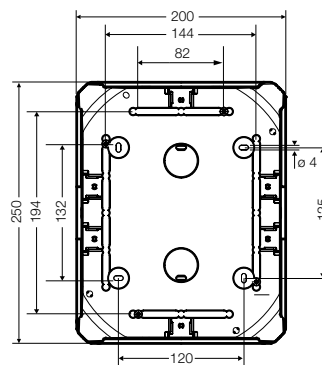

EB 25 G  
EB 25 B

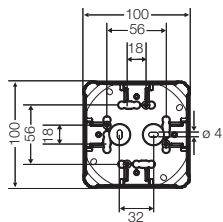

EB 04 G  
EB 04 B

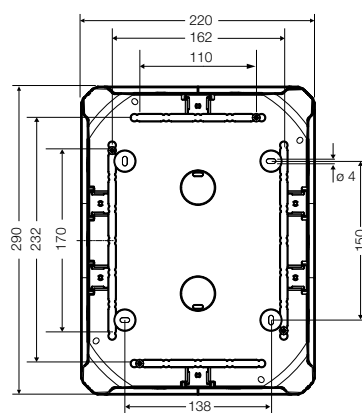

EB 35 G  
EB 35 B

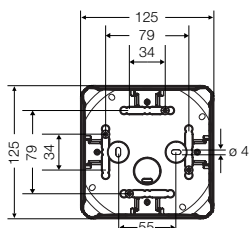

EB 06 G  
EB 06 B

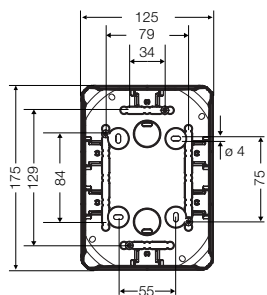

EB 10 G  
EB 10 B

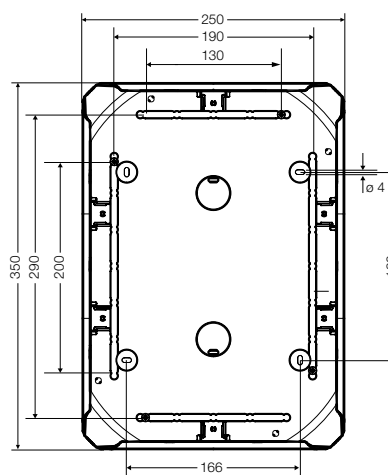

EB 50 G  
EB 50 B

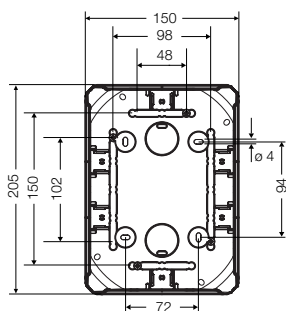

EB 16 G  
EB 16 B

Empty enclosures in accordance with IEC 62208  
 Technical details  
 Dimensions in mm

Dimensions of the interior installation depth with installed mounting plates.

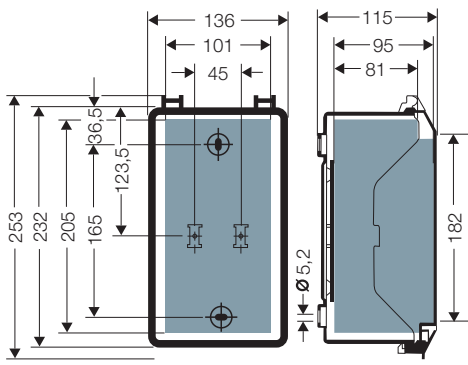

KG 9001  
 KG 9001 IN

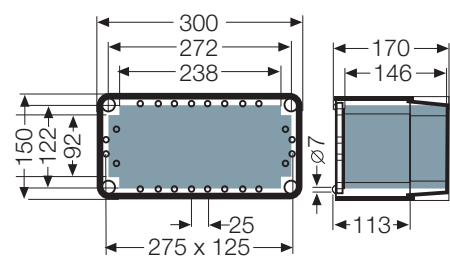

K 0100  
 K 0101

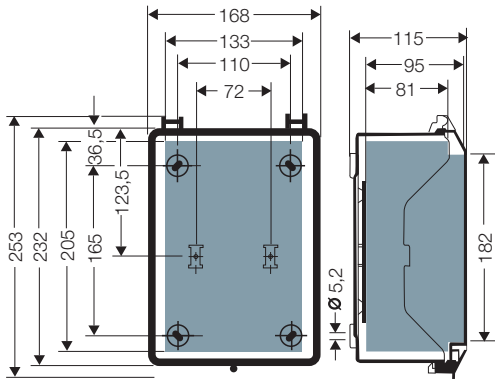

KG 9002  
 KG 9002 IN

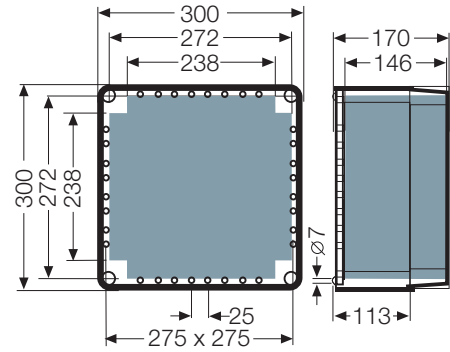

K 0200  
 K 0201

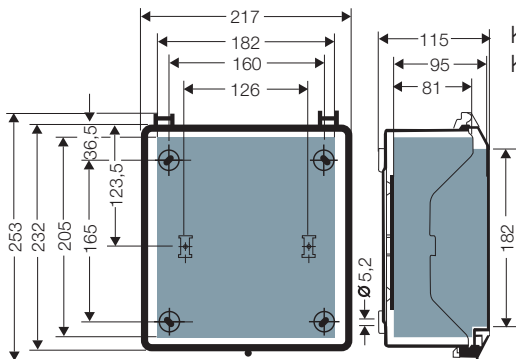

KG 9003  
 KG 9003 IN

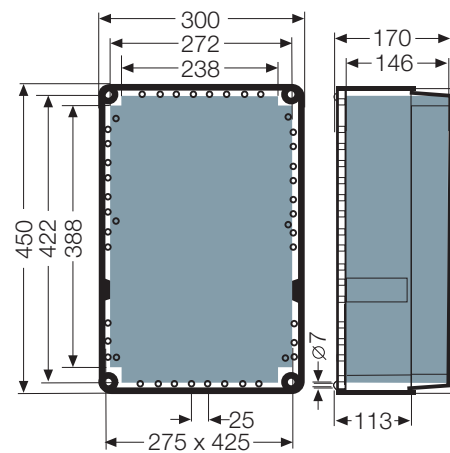

K 0300  
 K 0301

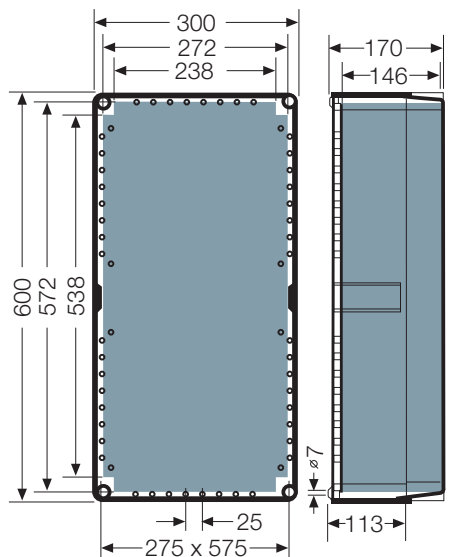

K 0400  
 K 0401

= usable installation space with mounted cable glands

EB empty enclosures: temperature rise ( $\Delta\theta$ ) by power dissipation of electrical devices

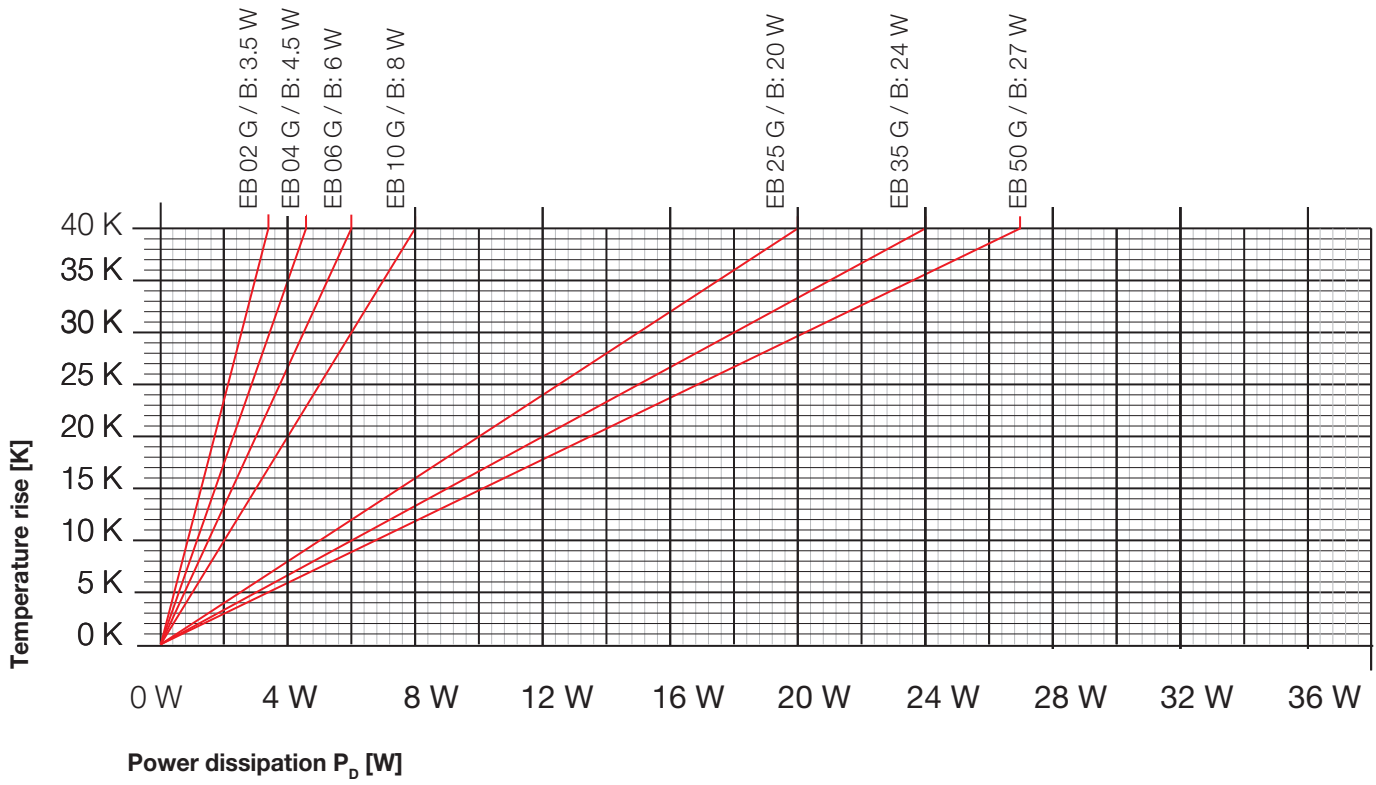

KG empty enclosures: temperature rise ( $\Delta\theta$ ) by power dissipation of electrical devices

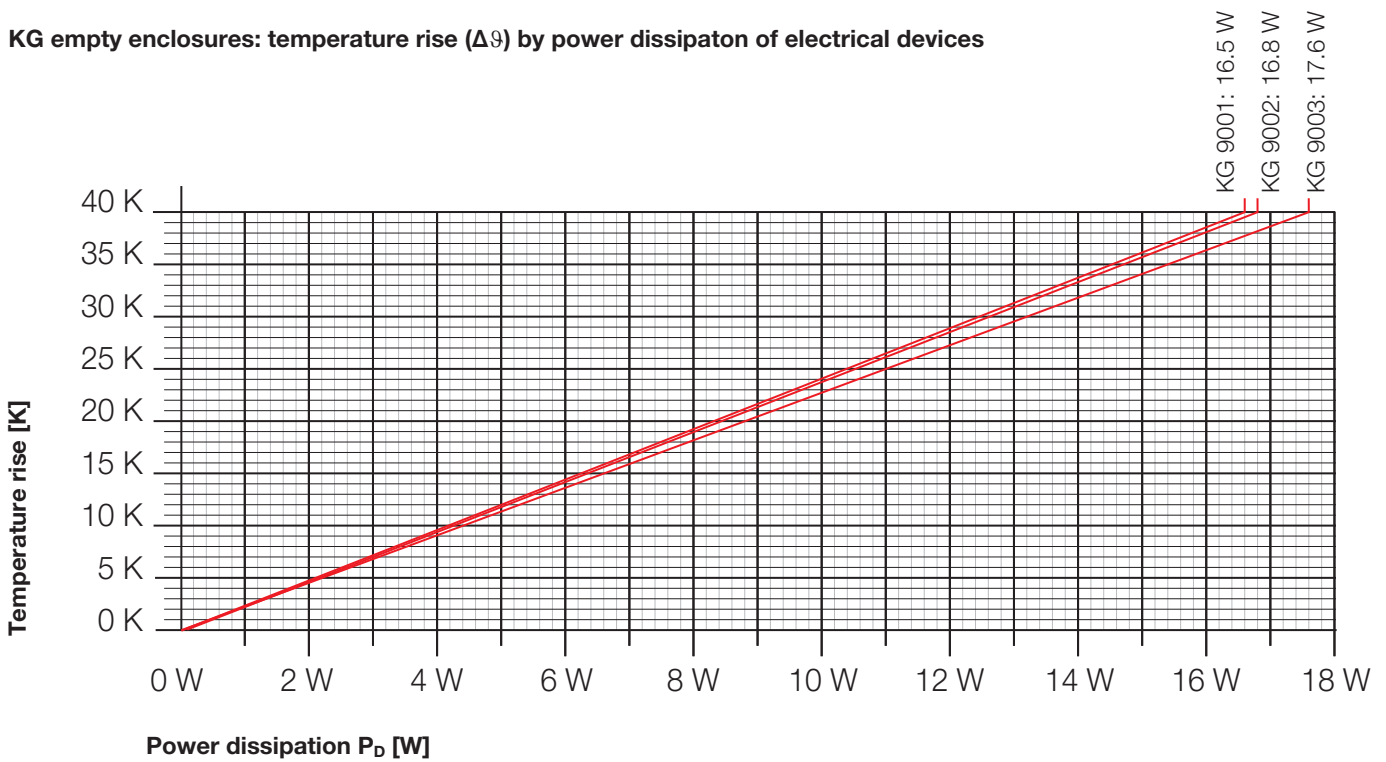

K empty enclosures: temperature rise ( $\Delta\theta$ ) by power dissipation of electrical devices

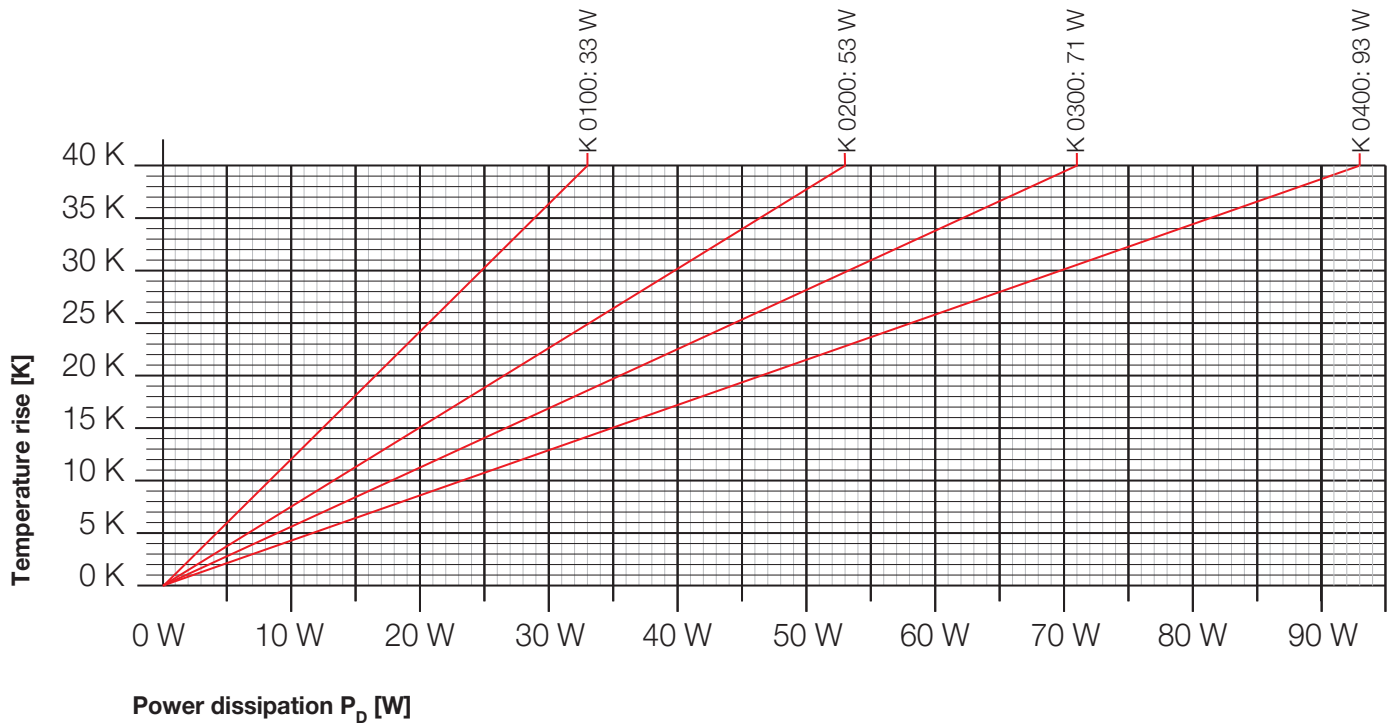

**Country-specific requirements have to be observed!**

**Requirements of German standard DIN VDE 0100 Part 737 for compliance with IP degree of protection**

**1. Requirement**

Protection against ingress of water for all electrical equipment (devices) with the appropriate encapsulation (2nd characteristic numeral)

1.1. Minimum requirement for electrical equipment:



**Note for outdoor installation:**

**„Protected outdoors“**

Electrical equipment has to be protected from precipitation (like rain, snow or hail) as well as from direct sunlight.

**„Non-protected outdoors“**

Electrical equipment can be exposed to precipitation or direct sunlight.

With both assembly sites the climatic effects on the installed equipment must be observed, for example, high or low ambient temperatures or condensation.

1.2. Minimum requirements for electrical equipment, that must withstand higher environmental stresses:

**degree of protection IP X 4**

with **non-direct** jets of water within occasional cleaning procedures, e.g. agriculture



**degree of protection IP X 5**

with **non-direct** jets of water within operational cleaning procedures, e.g. carwash



**degree of protection IP X 5 and additional consultation with the manufacturer:**

with **direct** jets of water within occasional cleaning procedures of enclosures, e.g. butcher's shop



**Country-specific requirements have to be observed!**

**2. Requirement of German Standard DIN VDE 0100 Part 737**

4.1 Electrical equipment must be selected taking into account the external influences to which they may be exposed. Proper operation and the effectiveness of the required degrees of protection must be assured.

Note: Data from the manufacturer!

**How does condensed water occur in enclosures with a high degree of protection?**

Condensed water only forms in enclosures with a higher degree of protection than IP 54 due to temperature difference from inside to outside. Humidity can not evaporate because of the high degree of protection of the enclosure.

System switched on.

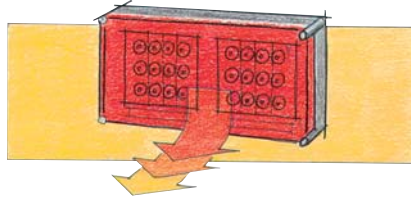

The internal temperature is higher than the external temperature due to the power dissipation of the built-in devices.

System switched on.

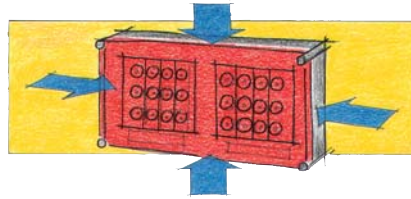

The warm air inside the enclosure attempts to accumulate moisture. This comes from outside through the seal as the enclosures are not gas-tight.

System switched off.

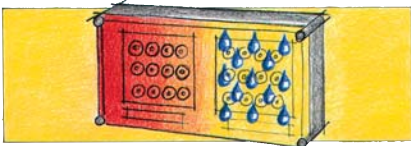

The internal temperature is reduced by cooling down the system e.g. by switching off the loads. The cooler air emits moisture which is collected as condensed water on the cooling inner surfaces.

**How does condensed water occur in enclosures with a high degree of protection?**

Formation of condensed water for **indoor installations:**

Formation of condensed water in **protected outdoor installations** (protected against weather influences) **or unprotected outdoor** installations:

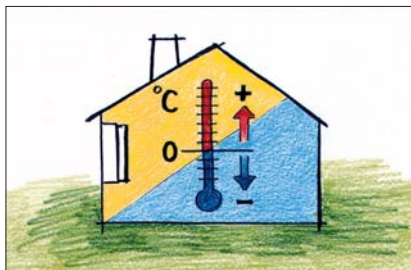

In areas where high levels of air humidity and large temperature fluctuations are expected e.g. in laundry rooms, kitchens., car washes etc.

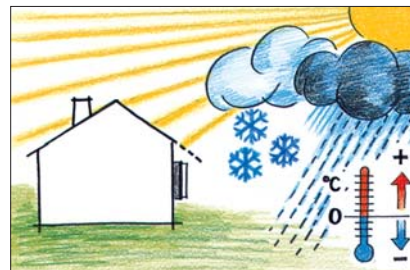

Here condensed water can be formed dependent on the weather, high air humidity, direct sunlight and temperature differences compared to the wall.

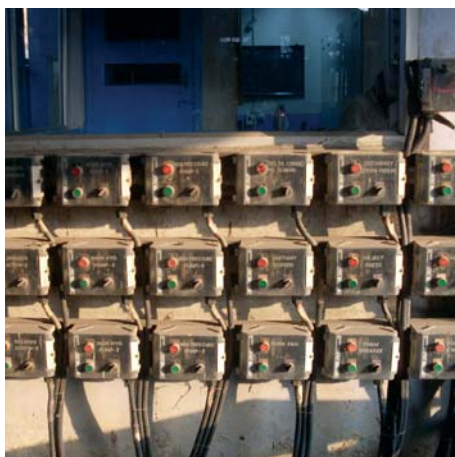





Products	Material used	Glow wire test IEC 60695-2-11	UL Subject 94	Temperature resistance	Chemical resistance <sup>1)</sup>					
					Acid 10 %	Lye 10 %	Alcohol	Petrol (MAK) 2)	Benzene (MAK) 2)	Mineral oil
<b>EB ... bottom parts</b> <b>K ... bottom parts</b>	PC (Polycarbonate) with GFS	960 °C	V-0	-40 °C / +120 °C	+	+	0	+	-	+
<b>K ... lids</b> <b>KG ... hinged lids</b>	PC (Polycarbonate)	960 °C	V-2	-40 °C / +120 °C	+	+	0	+	-	+
<b>KG ...</b>	PS (Polystyrene)	750 °C	V-2	-40 °C / +70 °C	+	+	+	-	-	0
<b>Sealing</b> <b>EB 02.. / EB 04.. / EB 06.. /</b> <b>EB 10.. / EB 16..</b> <b>KG ...</b> <b>ESM ..</b>	TPE (Evoprene)	750 °C	-	-25 °C / +100 °C	+	+	+	0	0	0
<b>Sealing</b> <b>EB 25.. / EB 35.. / EB 50../</b> <b>K ...</b>	PUR (Polyurethane)	-	-	-25 °C / +80 °C	0	+	0	0	-	+
<b>AKM .. / ASS .. /</b> <b>BM ...</b>	PA (Polyamide)	960 °C	V-0	-40 °C / +100 °C	+	0	+	+	+	+
<b>KBM .. / KBS ..</b>	PA (Polyamide)	960 °C	V-2	-40 °C / +100 °C	+	0	+	+	+	+
<b>Sealing</b> <b>AKM .. / AKS .. /</b>	CR/NBR (Polychloroprene - nitrile rubber)	-	-	-20 °C / +100 °C	+	+	+	0	-	0
<b>Sealing - inner part</b> <b>ASS ..</b>	TPE (Evoprene)	-	-	-30 °C / +100 °C	+	-	+	-	-	-
<b>Sealing - outer part</b> <b>ASS ..</b>	CR (Chloroprene rubber)	-	-	-30 °C / +100 °C	+	+	+	0	-	0
<b>Sealing</b> <b>KBM .. / KBS ..</b>	EPDM (Ethylene propylene diene monomer rubber)	-	-	-40 °C / +130 °C	+	+	+	-	-	-

(+ = resistance; 0 = partially resistance; - = not resistant)

1) The specifications on chemical resistance are a general guide. In individual cases it may be necessary to check resistance in combination with other chemicals and ambient conditions (temperature, concentration, etc.)

2) (MAK) - Maximum allowable concentration (work place)





**Gustav Hensel** GmbH & Co. KG

Gustav-Hensel-Str. 6

D-57368 Lennestadt, Germany

Phone: +49 (0) 27 23-609-0

Fax: +49 (0) 27 23-600-52

E-Mail: [info@hensel-electric.de](mailto:info@hensel-electric.de)

[www.hensel-electric.de](http://www.hensel-electric.de)

98171377 10.18/3/19

 made in **GERMANY**  
since 1931